

VOLUME 38 | NUMBER 12 | DECEMBER 2023

PRI

PERFORMANCE RACING INDUSTRY MAGAZINE

2024 BUYERS GUIDE



INSIDE: HUNDREDS OF
THE LATEST
MOTORSPORTS
PARTS, EQUIPMENT
& SERVICES!



...BUT YOUR ENGINE IS **CLEAN**



- Eliminate Engine Varnish
- Reduce Deposit Buildup
- Increase Performance
- Decrease Operating Temperatures
- Conquer Your Home Track



SERIOUS PERFORMANCE.

SERIOUS WHOLESALE POWER BY ATECH MOTORSPORTS.

- Access to Over 1,500 Brands
- Unbeatable Service and Satisfaction
- Huge Inventory—We Stock it so You Don't Have to
- Four National Warehouses
- FAST, FREE Shipping
- We Export at Competitive Rates



PRI 12/7-12/9 | **BOOTH #4601**

CONTACT US FIRST!

Atech Motorsports is the fastest, easiest way to access the best parts and brands in the industry at wholesale prices, with real-time inventory and pricing available to you 24/7. Our four national warehouses are packed to the rafters with millions of parts from 1,500+ brands—we continually add new brands all the time—ready to ship to your door at a moment's notice. Simply tell us your needs and give us the opportunity to become your go-to parts source for all things automotive.

HIGH PERFORMANCE
& RACE

LATE MODEL

TRUCK & DIESEL

JEEP & OFF-ROAD

STREET ROD
& RESTORATION

PREMIUM & STOCK
REPLACEMENTS



ATECHMOTORSPORTS.COM
FOUR LOCATIONS—MILLIONS OF PARTS!

TALLMADGE, OH • MCDONOUGH, GA • SPARKS, NV • ARLINGTON, TX
800.517.1040 • 1.330.630.0888 • FAX: 1.330.630.5365



Global Wholesale
DISTRIBUTOR

Some parts are not legal for sale or use in California or other states with similar laws/regulations. Please check your state and/or local laws/regulations. Typographical errors and errors in description or photography are subject to correction. ©2023 AUTOSALES, INC.



CONTENTS

DECEMBER 2023 VOLUME 38, NUMBER 12



PRI MAGAZINE



Engine Components.....8
State-of-the-art products—blocks, pistons, gaskets, crankshafts, cylinder heads, and more—for almost any type of powerplant.



Chassis, Driveline & Suspension72
All-new components—rearends, torque converters, clutches, shocks and springs, and more—for race car fabrication and parts sales.

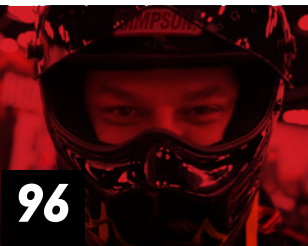

Racing Components, Accessories & Services..96
A collection of products and services—helmets, firesuits, fluids, sensors, trailers, and more—for teams, drivers, and vehicles.

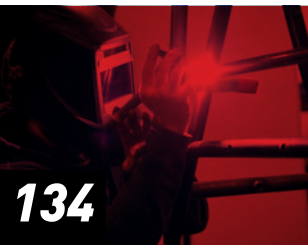

Machinery, Tools & Equipment 134
The latest machining and shop equipment designed to enhance cutting, honing, porting, surfacing, grinding, testing, cleaning, and more.



Race Track Equipment 156
New solutions and services designed to improve operations through better track conditioning, communications, safety, and elsewhere.



Sanctioning Bodies 160
A comprehensive list of organizations that regulate and coordinate the various events and series that fall under their authority.

Manufacturers' Representatives..... 178
Leading firms that connect suppliers and customers—from the largest WDs to the smallest speed shops and engine builders.

Warehouse Distributors 185
Providers of valuable storage space as well as communication tools, technical support, cataloging, and other useful services.

Suppliers Index..... 187
Reference and contact information for hundreds of leading product suppliers representing all forms of motorsports.

DEPARTMENTS

Performance Industry Reps 195
Advertisers Index..... 196

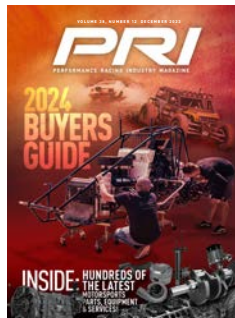

ON THE COVER
Cover Imagery: Contributed/
Layout by John Cabral

GENERAL MANAGER
Jim Liaw

EDITORIAL

EDITORIAL DIRECTOR
Jason Mulrone

EXECUTIVE EDITOR
Meredith Kaplan Burns

**SENIOR EDITOR /
SOCIAL MEDIA MANAGER**
Christen D'Alessandro

CONTENT EDITOR - DIGITAL
Laura Pitts

COORDINATING EDITOR
Jack Haworth

CONTRIBUTORS
Drew Hardin, Bradley Iger, Mike Magda

SALES

VICE PRESIDENT OF SALES
Warren Kosikov

SENIOR SALES DIRECTORS
Alan Josse Brian Paik

INDUSTRY SALES DIRECTORS
Andrea Brake Celina Kluba
Becca Butler Monica Terfouw
Jeff Dahlin Willie Yee
Scott Hartwick

SALES ASSISTANTS
Mary Crum Karina Mendez
Madison Danna Lisa Schafer

PRODUCTION

GROUP OPERATIONS MANAGER
Janet Lee

ART

GROUP ART DIRECTOR
Paul Graff

GRAPHIC DESIGNERS
John Cabral
Jeffrey Chhan

PHOTOGRAPHERS

Michael Allio, Mike Campbell, Driveline Studios, Alex Wong

ACCOUNTING

PAYABLES
Lily Huang

Performance Racing Industry (ISSN 1045-3024) is published monthly in the interest of the growth and development of the racing market, consisting of manufacturers, retailers and racing participants. *Performance Racing Industry* can be contacted at 27081 Aliso Creek Rd, Suite 150, Aliso Viejo, California 92656, 949/499-5413, Fax 949/499-0410. Periodicals Postage paid at Laguna Niguel, CA 92677, and additional mailing offices. **Postmaster:** Send address change to *Performance Racing Industry*, 27081 Aliso Creek Rd, Suite 150, Aliso Viejo, California 92656. No part of this magazine may be reproduced without written consent of the publisher who is not responsible for the unsolicited material. *Performance Racing Industry* is sent to the retailers, distributors, manufacturers and racing participants within the United States. Subscriptions are complimentary to qualified members of the racing industry. "Performance Racing Industry" is a trademark owned exclusively by SEMA. © 2023 Performance Racing Industry. All rights reserved.

Printed in U.S.A.

PM # 40702022, Return Undeliverable Canadian Addresses to: Station A, PO Box 54, Windsor, ON N9A 6J5. Email: cpcreturns@windsor.com

Be last.

Being the last on the brakes isn't just a test of skill, it's also a test of how much confidence a driver has in their brakes.

With unique **Fade Resistant Technology™**, **Halo P1** has a far lower and far more stable level of compressibility over a wide temperature range than the competition—giving drivers the confidence that their brake fluid will perform as well on the last lap as the first.

Formulated for the art of braking.

halo.
By Orthene.

halobyorthene.com



“Unique revolutionary concept in valve guide honing.”

**Cylinder Head
 GUIDE MACHINING**

- Automatic Guide Honing
- Core Drilling
- Reaming

NEW DESIGNS BY ROBINS US 7,726,919 B1 | US 17879818 | US 17892165 (Patents pending)

WORLD'S FIRST

**Automatic Valve Guide
 Machining System**



GH 8 SMART
 Total Valve Guide
 machining solution

NEW

**Cross Hatch & Plateau Honing Tools
 to Control Rpk, Rk, Rvk**



- To improve surface finish in guide bore.
- Less wear - reduced friction.
- Better Lubrication .
- Better sealing - more power for improved engine performance.
- Tighter clearance - near zero - valve seat concen.

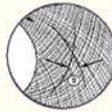

- **Automatic Honing Cycle**
 Stock removal from
 0.00005” to 0.004”
 in one cycle.
- **Automatic Ream &
 Hone cycle**
 Stock Removal in
 excess of 0.004”.
- **Automatic Cross
 Hatch & Plateau**
 New Honing Tools to
 control Rk, Rpk & Rvk.



YouTube
 Robins Machines

SCAN TO WATCH

Guide Honing Video
 Stock removal 0.006”
 Run time One minute

Machines displayed may include optional accessories

AUTOMATIC VALVE GUIDE MACHINING SYSTEM

(For Engine Rebuilders)

Accurate to 0.0001” (0.002 mm) Automatically !

rc@RobinsMachines.com

www.RobinsMachines.com

EVERY CUSTOMER SINCE 1983 HAS BEEN “ROBINS-TESTIMONIAL”

- Seat & Guide
- Surfacing
- Guide Honing
- Valve Grinding
- Cylinder Boring

Seat & Guide Smart Series with Dual- MICRO- Centering System

SG12
Smart



ROBINS Dual Centering System

Smart series machines include additional centering / work head float system that precisely centers small diameter pilots in valve guides, ensuring near zero valve seat run-out.



SG 6in1 Next Generation Seat & Guide Machine

- **Manual-Automatic-Manual** seat and guide machine. (Latest from Robins)
- Switch from Manual to automatic to Manual cycles with touch of a button.
- Machine Valve Seats using either Live or Fixed pilot tooling.
- **Also machine with Dual-3 angle seat inserts** -calibrated to exact seat dia .
- **Optional** – guide honing software & accessories for **SG 6 in1** to hone guides within 0.0001" bore accuracies.



Dual 3-angle insert setting device to precise seat dia.

Machines displayed may include optional accessories



SECTION

1

ENGINE COMPONENTS

Horsepower heaven can be found throughout this first section with a variety of motorsports components dedicated to engines, from air cleaners to valves, and connecting rods to water pumps. Turn to the following pages to fill the need for speed with everything devoted to the various powerplants found at race tracks every week.

MICKEY THOMPSON



TIRES & WHEELS

UNDISPUTED TRACTION

FOR STREET, DRAG,
TRUCK, AND EXTREME
OFF-ROAD.

SEE US AT
BOOTH #3831



ARE DRY SUMP SYSTEMS

drysump.com | 916-652-5282



NEW REMOTE OIL FILTER ADAPTER

- Built-in adjustable oil pressure regulator
- For dry sump or wet sump engines



SCREEN FITTINGS

- Screen fittings and custom-built screen filters built to your specifications
- Used in Formula One, NASCAR, IndyCar, and more



ATMOSPHERIC VENT CANS

- Patented design
- CNC-machined billet
- Available in .6L, 1L, and new 2L sizes
- Available with all AN fitting sizes



DRY SUMP PANS

- Made from aircraft alloy
- CNC machined



SPEED

RUNS IN
THE FAMILY



PROXES RS1
Full-slick competition



PROXES RR
DOT competition



PROXES RA1
DOT competition



PROXES R888R
DOT competition



PROXES R1R
Extreme performance summer



TOYO TIRES®

ROBINS
SINCE 1983
Signature brand



- Seat & Guide
- Surfacing
- Guide Honing
- Valve Grinding
- Cylinder Boring

VR 10P

Valve Refacing

New Features

- **Diamond & CBN Grinding wheels** offering Long Life & Less frequent wheel dressing.
- **Ball Chuck** now available with optional **ceramic balls** offering life long precision.
- **Foot switch** added for hands-free chuck operation.
- **Large V-nest** for diesel valves.



Machines displayed may include optional accessories

ROBINS
SINCE 1983



1983
40 Years of
Excellence
2023



/robinsmachines

rc@RobinsMachines.com

www.RobinsMachines.com

youtube.robinsmachines.com

Perfection - Innovation - Leadership

EVERY CUSTOMER SINCE 1983 HAS BEEN "ROBINS-TESTIMONIAL"

“WITH MANY NEW & ADVANCED FEATURES”

RUBI SURF

1.7 Smart Automatic



****No Precision Locators Needed****

RUBI SURF 1.7 SMART
Automatic

X-axis workhead travel: 42 inches (1065 mm)
Cylinder head length: 34 inches (865 mm)
Cutter head diameter: 14.0 inches (356 mm)

ROBINS..First
Keep both

V-Block fixture & Cyl. Head Tilt fixture
on machine base while surfacing
either Cyl. Head or Cyl. Block

Caterpillar C15
Cylinder Head



SCAN TO WATCH

RUBI SURF

1.9 Heavy Duty Automatic



RUBI SURF 1.9 SMART
Automatic

X-axis workhead travel: 56 inches (1400 mm)
Cylinder head length: 47 inches (1200 mm)
Cutter head diameter: 16.5 inches (420 mm)

NEW

RUBI SURF

1.6 M CNC
Manual



3 in one Universal fixture

- V Blocks
- Cylinder Heads
- In-Line Blocks

NEW

Machines displayed may include optional accessories

NEW

RUBI SURF 1.6 M CNC

Manual

X-axis workhead travel: 42 inches (1065 mm)
Cylinder head length: 34 inches (865 mm)
Cutter head diameter: 14.0 inches (356 mm)

ENTRY LEVEL - EXTREME HIGH PRECISION



SCAN TO WATCH
RUBI SURF 1.6M cnc
Video

ARP

arp-bolts.com | 800-826-3045

**ARP CUSTOM AGE 625+ HEAD STUDS**

- All ARP Custom Age 625+ Studs are centerless ground, heat-treated prior to thread rolling and machining, nominally rated at 260,000–280,000 psi tensile strength and are reusable compared to the OEM Torque to Yield (TTY) head studs
- Optimum design, enhanced reliability and increased strength are the main attributes of ARP's Main Stud Kits

**ARP ROD BOLTS**

- ARP has over 500 stock rod bolts with material tensile strength from 180,000 to 280,000 psi
- Special orders are available
- Bolts are reusable as compared to the OEM Torque to Yield (TTY) rod bolts, which must be replaced after each use
- Optimum design, enhanced reliability and increased strength

**ARP ACCESSORY FASTENERS**

- Engine and accessory fasteners that are superior in strength to OEM
- Offered in both polished ARP Stainless and 8740 Black Oxide finish in both hex and 12-point heads, rated at 180,000 psi tensile strength

**ARP WHEEL STUDS**

- Available in press-in studs for most domestic and sport compact vehicles as well as screw-in studs for aftermarket axles
- Made from 8740 chromoly steel
- Heat-treated to a nominal tensile strength of 190,000 psi
- ARP offers 1/2-20 screw-in studs up to 3.470-inch underhead length

Booth 1501
PRI SHOW
 DECEMBER 7-9, 2023, INDIANAPOLIS

Nickels 
 PERFORMANCE DISTRIBUTORS
 nickelsperformance.com



Visit Booth 725 To See
 These Products & More
 from the Edelbrock Group



Edelbrock

NEW PRODUCT!

Victor CNC 12-Degree Cylinder Heads for GM Big Block Chevy Engines

- Premium H.I.P. Aluminum Alloy
- Fully CNC Ported
- Raised and Spread Intake Ports
- Raised Exhaust Ports
- Copper Intake & Exhaust Valve Seats
- Conical Chamber Design
- 2.500" x 1.800" Valve Job

Part #	Port Volume	Chamber	Conical Machining	Spark Plugs	Valve Size		Valve Seat	Valve Train
					In.	Ex.		
618270	498cc	82cc	Yes	Angle	2.500"	1.800"	Copper	Bare

CALL YOUR REP OR VISIT
 NICKELSTORE.COM TO PURCHASE

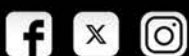

TN: 800-251-0331 | FL: 866-520-1932



BR MOTORSPORTS IGNITIONEERING

brpromag.com | 559-739-1515

BRpromag.com



BR BLACK MAGIC PRO MAG 44

- Most powerful magneto in company's lineup
- Proprietary rare earth magnets
- Hand-wound induction coil
- BR's Blue Print technology



BR BLACK MAGIC PRO MAG 20

- Same magneto as the Pro Mag 44 with the exception of the induction coil
- Allows the 20 AMP to be used with a MSD 8106 spark box instead of a separate control box and coil system



BR BLACK MAGIC 12LT

- Blue Printed, which means extensive CNC machining and hours of calibration and special proprietary wiring including an external ground loom with water-tight connector as well as assembly procedures using the company's all new billet zero tolerance set-up fixtures



BR BLACK MAGIC LOW PRO 12LT

- Will allow you to lower your air filter system down a full 2 inches
- Increased horsepower because you can get more air into your air filter and also run shorter stacks
- Proven winner
- Has all the same great features as all the other BR Black Magic magnetos

**DRIVE
TAKES
YOU
FURTHER**

GOODYEAR
MORE DRIVEN.

Goodyear celebrates drivers and teams that move beyond what's possible to reach their highest potential.



SPORTSCAR & FSAE



DRAG & LANDSPEED

Goodyear Company. All Rights Reserved.

CP-CARRILLO

cp-carrillo.com | 949-290-0189



GODZILLA FORD 7.3L CONNECTING RODS

- Made in the USA from our trusted Carrilloloy, 4330 modified
- Rated for 1,800 horsepower and 8,500 rpm
- Accepts 7.3L & Modular 4.6, 5.0L, 5.4L bearings



GODZILLA FORD 7.3L V8 2020-23 PISTONS

- Rated for 1,500 horsepower
- Available in two bore sizes: 4.225 + .005 and 4.250 + .030
- Includes .043, .043, 3.0-mm heavy-duty steel ring pack
- 10.5 compression ratio using E85 with a 1.338 compression height
- .990-inch diameter chromoly pins with .200-inch wall
- Lateral gas ports



TOYOTA YARIS GR G16E-GTS PISTONS AND RODS

- Rated for 900 horsepower drag race, or 750 horsepower road/rally racing
- Available as a combo with standard or plus 4-mm rod length
- Unique long-rod combo offers 50-gram piston weight savings, improving overall reciprocating mass and rod ratio
- Long-rod combo should also help provide longer bearing life



HEAVY-DUTY SHELF PISTONS FOR BMW B48/B58/TOYOTA SUPRA A90 SC8705

- Manufactured in the USA from CP's heavy-duty forging
- Designed specifically for heavy boosted applications
- Supplied with upgraded 9310 ultra-duty .250-inch-wall pins
- Includes CP's upgraded rings with PVD coating
- Good for around 1,800 horsepower



YOUR COMPETITIVE ADVANTAGE

TURN14
DISTRIBUTION

x

AEROMOTIVE

GEN II STEALTH FUEL TANKS - 200 & 340 LPH

Turn 14 Distribution is the premier B2B source for Aeromotive's performance fuel components. As a valued dealer, we provide you with access to industry-leading customer support, real-time inventory, flat rate shipping from our strategically located distribution centers, and 100% hassle-free returns.

100% WHOLESALE | TURN14.COM

DAYCO

na.daycoaftermarket.com | 800-848-7902



DAYCO 8-MM BLOWER BELT

- Engineered for pro-modified cars, Top Alcohol dragsters and high-performance street cars
- HNBR rubber construction for maximum heat and oil resistance
- High durometer HNBR and Teflon coating for highest tooth strength
- Carbon cord construction offers extreme durability and performance
- Available in multiple lengths and 50-mm, 75-mm and 84-mm widths



DAYCO SUPERCHARGER BELT

- Engineered for late model high-performance supercharged street cars like ZR1 Corvettes, Shelby Mustangs and SRT Hellcat applications
- Aramid fiber loaded EPDM construction and high stiffness PET cords eliminate belt stretch
- Extreme durability and reduced slip under high-boost conditions
- Extensive on-the-track testing by Watson Racing



POWERBOND BY DAYCO RACE SERIES HARMONIC BALANCERS

- Dayco's harmonic balancers bring the advantages of bonded balancers to high-revving, high-horsepower applications where an SFI-approved balancer is required
- Tested beyond 21,000 rpm without failure
- Precision CNC-machined AISI 1045 forged steel hub
- Laser-etched timing marks for easy timing changes
- Engineered to be lightweight for an all-steel product



DAYCO TIMING CHAIN KITS

- Dayco's timing chain kits make it easy to conduct a thorough repair using precision engineered parts
- High-quality chains prevent stretch, addressing the number one replacement issue
- Premium sprockets fit flawlessly for exact timing
- High-grade plastic guides provide excellent wear resistance
- Backed by a two-year or 60,000-mile parts and labor warranty

WE POWER WHAT DRIVES YOU

Thank you for your continued loyalty and business



Let's make it a Powerful 2024!



DELTA PAG

deltapag.com | 212-203-2912



MONO-CORE ALUMINUM RADIATORS

- Newly designed aluminum radiator cores by Delta PAG use only one extra-wide tube vs. multiple smaller tubes
- Unique Mono-Core design increases air velocity effectively increasing heat dissipation
- More space for proper shrouding and fan assembly
- One row is better than a four-row



BRUSHLESS WATER PUMP

- 60 gallons per minute (227 liters per minute)
- Variable speed acts like a virtual thermostat
- Removal of conventional thermostat increases top-end flow rates
- Brushless so will last for +50,000 hours
- Inlet single AN20, outlets dual AN12



BRUSHLESS COOLING FANS

- More airflow up to 4,100 cfm
- Thinner at only 2.70 inches
- Soft Start eliminates power spikes
- Variable speed runs extremely efficiently
- Unique designed small brushless motor packs a punch
- 12, 14, 16, and 18 inches



DIGITAL TEMPERATURE CONTROLLER

- Dual-channel digital temperature/speed controller
- Set on and off settings for two fans or pumps
- Increases and decreases speed of fan or pump via PWM outputs
- Accurate at 1% temperature
- Bright 3-inch display, use as your primary temp gauge

DRIVING THE FUTURE OF AUTOMOTIVE PERFORMANCE

Edelbrock Group™ elevates automotive performance by unifying the most iconic brands and products in the aftermarket. We believe in promoting and expanding the love for the automotive lifestyle by investing in the next generation of enthusiasts. Whether on dirt, asphalt, street, or strip, the Edelbrock Group family of brands offers an unrivaled advantage over the competition by building on decades of experience, passion, and innovative thinking from the most brilliant automotive minds. We stand firm in our commitment to providing next-level solutions and quality products through superior engineering and exceptional service for all customers.

**STOP BY OUR PRI BOOTH #725 IN GREEN HALL
TO SEE OUR INNOVATIVE NEW PRODUCTS FOR 2024**

SCAN HERE

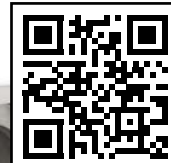

Edelbrock

COMP
CAMS

TCI
AUTOMOTIVE

FAST
FUEL AIR SPARK TECHNOLOGY

RUSSELL

LUNATI

edelbrockgroup.com | Phone: 800.365.9145 | #EGNation

FITECH FUEL INJECTION

fitechefi.com | 951-340-2624

FiTech
Fuel Injection



RETRO LS PORT 750 HP EFI SYSTEM FOR LS1 OR LS3

- Retro Port LS EFI for LS1 and LS3 applications
- E85 compatible
- Old-school appearance
- Built-in transmission control
- High-horsepower support and boost/nitrous compatibility
- Complete kit equipped with cast intake, classic series throttle body injection, -6 AN and -8 AN fittings, a fuel pressure regulator, sensors, fuel rails, injectors, and an ECU



ULTIMATE REBEL LS EFI SYSTEM

- Designed for enthusiasts seeking both power and aesthetics
- Cleaner profile for better dressed engine bay
- E85 compatible
- Advanced fuel injection technology
- Boost/nitrous compatibility – equipped with 3 bar MAP sensor (27 PSI)
- Options to support up to 500, 750, and 1,000 horsepower
- Complete kit equipped with manifold, ECU, sensors, throttle body, harness, and more



GO SPARK ADVANCED CDI & COIL

- Adjustable spark energy output; 275mJ for the street or 585mJ for the strip
- Rev limiter settings for burnout, launch, and max engine over-rev protection
- Digitally controlled for precise timing control
- LED shows live rpm or battery voltage, with buttons for adjustments
- High energy coil to maximize CDI performance benefit



FITECH UNIVERSAL 4 BARREL THROTTLE BODY

- 4150 flange throttle body
- 1,000+CFM
- Compatible with TMAP or MAP sensors
- Threaded IAT port for boosted blow-through applications
- Built on IAC motor
- Vacuum ports
- Also available in bright finish

WILWOOD RACING

NEW!

WIDE 5 STARLITE 55XD LUG-DRIVE HUBS

The Starlite 55XD Lug-Drive hub combines three Wilwood innovations to create a strong, light racing hub for the most demanding race tracks.



XRZERO ZERO-DRAG RACE CALIPERS



XR RACE-ONLY BRAKE FLUID

645° F dry boiling point is one of the highest of any brake fluid and performs under the most extreme high temperature conditions



Bubba Pollard | Asphalt Late Model

LEARN MORE



wilwood.com
805.388.1188

VISIT OUR BOOTH AT **PRI** #809



WILWOOD RACING

POWER. CONTROL. PRECISION.

HOWARDS CAMS

howardscams.com | 920-230-4241



BELT DRIVE TIMING SETS

- Designed for reduced valvetrain harmonics and precise valve timing
- Simple valve-timing adjustments in minutes
- Quick and easy cam changes
- Applications for Chevrolet SB (std. & raised cam), LS & BB; Dodge/Chrysler SB, BB/426 Hemi; Ford 302-351W & FE



BILLET STEEL LS RELUCTOR WHEELS

- Designed to eliminate the failures due to reluctor slipping on the crankshaft
- One-piece design for accuracy and virtually no deflection for precise ignition timing
- CNC-machined from billet steel to the highest tolerances
- Accurate, reliable, a must for all LS performance and race applications
- Chevrolet/GM 24- and 58-tooth



TRACK SMART 4340 FORGED H-BEAM RODS

- Precision CNC-machined
- Certified 4340 aircraft quality steel
- Special heat-treat to ensure strength and reliability
- Fully stress-relieved and shot-peened
- X-rayed and ultrasonically tested
- 7/16-inch ARP 2000 fasteners



BILLET REAPER E4340 BILLET CRANKSHAFTS

- Manufactured from E4340 aircraft quality billet bar stock
- Computer-designed counterweights for reduced bearing loads and improved balance
- CNC-machined to exacting tolerances
- Full eight center-counterweight design
- Deep nitride hardened
- Fully stress-relieved and shot-peened
- Large fillet radii on all bearing journals

ALL IN-STOCK ORDERS SHIP OUT WITHIN 1 TO 3 BUSINESS DAYS



QUANTUM

M A C H I N E R Y G R O U P

THE LEADERS IN METALWORKING MACHINERY & WELDING TABLES

PROVIDING HIGH-QUALITY EUROPEAN EQUIPMENT
AT UNRIVALED PRICES TO THE UNITED STATES MARKET!

siegmund® WELDING TABLES

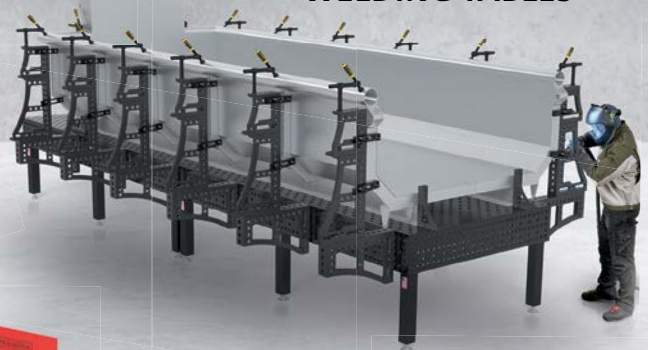

NARGESA®



WHAT WE OFFER

PRESS BRAKES
BAND SAWS
WELDING TABLES
IRONWORKERS
CUTTING LINES
AND MORE!



MACC
MADE IN ITALY



QUANTUMMACHINERYGROUP.COM
(704) 703-9400

WANT TO TAKE YOUR METALWORKING TO THE
NEXT LEVEL?

VISIT US ONLINE TO SEE THESE MACHINES
IN ACTION OR CONTACT US FOR A QUOTE.



SCAN WITH
PHONE CAMERA

JMS PERFORMANCE GROUP

jmschip.com | 601-766-9424

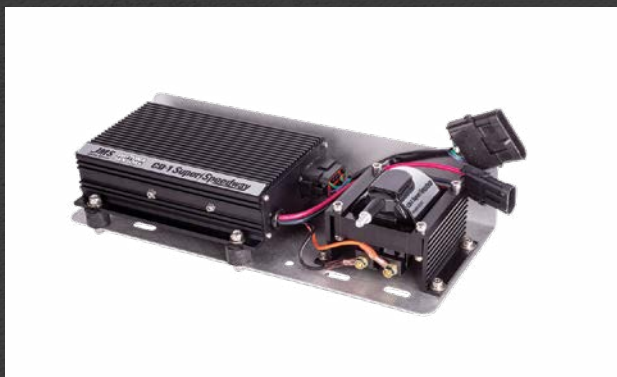

JMS CD-1 SUPER SPEEDWAY—PROFESSIONAL RACING IGNITION SYSTEM

- Plug-and-play capacitive discharge racing ignition system for Late Model crate engine racing
- Part number 6000-6701K
- Approved racing ignition system: Southern Super Series, CARS Super Late Model Tour, SPEARS Southwest Tour Series, ACT Series Tour
- 135 mJ spark energy, encapsulated construction, highly resistant to vibration and shock



JMS SMART SPARK—TRANS-AM SERIES TA2 LS IGNITION SYSTEM

- Complete kit with wiring harness
- TA2 ignition system for Chevy LS engines
- Part number TA2SSLS-K
- Supports approved TA2 GM LS racing engines (carbureted LS engines with 58-tooth crank trigger)
- Pre-programmed with approved TA2 ignition timing advance tables, sealed for the TA2 racing series



JMS FUELMAX—FUEL PUMP BOOSTER

- Plug-and-play—Dodge, GM, Ford
- Boosts fuel pump voltage equals more fuel pump flow
- 22-volt max output
- User adjustable
- Support up to 1,000-hp single pump and 1,300 hp with dual pumps
- Direct wire-in version available for racing



JMS TRACTIONMAX—SLIPPING AIN'T WINNING

- Optimize acceleration and traction and increase throttle response
- Most vehicles supported
- Simple install and setup
- Includes dual adjustment dial
- Compatible with factory and aftermarket tuning
- Designed and assembled in the USA

BOOTH 2735



Complete Ford 9 Rear Ends

Housings | Axles | Third Members | Brake Kits
Gears | Spools | Differentials | Bearing Kits

Direct Fit Ford 9" Rear Ends

All New Construction
Laser-Cut, Jig-Welded Brackets
Ships to Any Location
Built-to-Order

Many Options Available Including:

- Custom Widths
- Powdercoating
- Gun-Drilled Axles

Common Complete Rear End Builds:

450HP Street/Strip Rear End Starting at \$2145

1,000HP Drag Racing Rear End Starting at \$2309

(Includes Housing, Axles, Third Member and Brakes)



GM 82-02 F-Body
with Tubular Torque Arm Bracket



1, 2, 4, and 6 Piston Brake Kits



Race Ready Center Sections

Starting at
\$1040



GM Half-Ton Truck with Flipped Perches



QUICKPERFORMANCE.COM

515.232.0126

MELLING PERFORMANCE

melling.com | 517-787-8172



HIGH-PERFORMANCE HYDRAULIC ROLLER CAMSHAFTS FOR HEMI 5.7L, 6.1L, 6.2L & 6.4L

- Four new part numbers available
- For non-MDS engines without VVT
- Single Bolt – 114-degree lobe separation
- # 23107 0.520" Intake Valve Lift • 0.520" Exhaust Valve Lift
- # 23207 0.575" Intake Valve Lift • 0.575" Exhaust Valve Lift
- # 23108 0.520" Intake Valve Lift • 0.520" Exhaust Valve Lift
- # 23208 0.575" Intake Valve Lift • 0.575" Exhaust Valve Lift



HEMI 5.7L & 6.1L OHV HIGH-VOLUME OIL PUMP

- PN 10452HV
- 20% higher volume than stock
- High-pressure spring installed
- Threaded pressure-relief nut
- Stock pressure spring included
- Cast aluminum housing
- Anodized hard-coated body and cover
- Exclusive rotor set
- Uses standard bolt-on screen
- Includes oil pump screen mounting O-ring



HIGH PERFORMANCE VALVE SPRING SET FOR HEMI 5.7L & 6.4L

- PN 46654-16
- Closed height/load: 1.800-inch @ 130 lbs
- Open height/load: 1.230-inch @ 348 lbs
- Solid height: 1.147-inch max
- OD: 1.019/1.199 inch
- ID: 0.645/0.825 inch



ENGINE PLUG KITS FOR GM LS

- PN MOGP-100
- Replacement for OE PN 12573460
- Visit melling.com to find more parts for your performance engine build

MAXX-D TRAILERS

More than just car haulers.
A full lineup of trailers built for the working man.



COME SEE **BURNY77** AND **MAXX-D**
AT THE **PRI** SHOW

INDIANAPOLIS, IN
DEC 7-9



Visit **BOOTH 8050** for a chance
to win a 2024 all-expense-paid
trip to any **NHRA RACE!**

MAXX-D
TRAILERS

BURNY77
J&B Harts

MELLING PERFORMANCE

melling.com | 517-787-8172



VALVE SPRING KITS FOR GM LS ENGINES

- 14 new valve-spring-kit part numbers available
- Each kit contains:
 - Eight intake valve stem oil seals
 - Eight exhaust valve stem oil seals
 - 16 valve springs
 - 16 titanium or steel valve spring retainers
 - 16 valve locks (32 pcs)



HIGH PERFORMANCE LIFTERS FOR GM 4.8L, 5.3L, 5.7L 6.0L & 6.2L

- Three part numbers available: 29ST2126LSR / 292110R / 292116LSR
- Cold-forged steel body and heat-treated for exceptional wear resistance
- Precision ground needle roller bearings with high chromium steel axle for long life and minimal friction



NEW CAMSHAFT KITS FOR GM LS APPLICATIONS

- 88 new kit part numbers available
- Featuring 22 different camshaft profiles
- Made in the USA – steel core camshafts
- Options of dual or beehive valve springs
- Options of titanium or chromoly retainers
- Kits include Viton valve-stem seals, valve locks, chromoly pushrods and thrust plate



NEW CAMSHAFTS FOR GM GEN V/LT APPLICATIONS

- Tri lobe billet steel – Made in USA
- PN 22329 valve lift .502/.494, duration at .050 193/199
- PN 22330 valve lift .639/.639, duration at .050 224/238
- PN 22331 valve lift .639/.639, duration at .050 230/244
- PN 22332 valve lift .639/.639, duration at .050 218/230

DRIVE WITH CONFIDENCE: ENHANCE YOUR TRUCK'S LONGEVITY WITH PREMIUM FILTERS

PREMIUM HIGH-EFFICIENCY ENGINE OIL FILTERS

The PPE Premium High-Efficiency Oil Filters is just what your engine needs for maximized protection and prolonged oil life. Each PPE Filter is equipped with larger, more efficient filter media, a high-power magnet that traps metal particles, a silicone anti-drain-back valve that eliminates engine dry starts, and a stiffer, rubber-sealed bypass valve. The PPE Oil Filter is the ultimate choice for your engine. Upgrade today.

Replaces: AC Delco PF26

P/N 114000750

Applications:

2020-2024 GM
6.6L Duramax

Replaces: AC Delco PF66

P/N 114000650

Applications:

2019-2024 GM
3.0L Duramax

Replaces: Motorcraft FL-2051-S
Motorcraft FL-2124-S

P/N 314000767

Applications:

2011-2023 Ford Superduty
6.7L Power Stroke



SCAN TO LEARN MORE!

PPE

PACIFIC PERFORMANCE ENGINEERING

PPEpower.com | 725.238.2002

Innovations in performance.

MOLNAR TECHNOLOGIES

molnartechnologies.com | 616-940-4640

MOLNAR
TECHNOLOGIES LLC



EIGHT COUNTERWEIGHT LS BILLET 4340 CRANKSHAFT

- A true billet crankshaft with counterweights located to reduce bending and flexing in high-rpm engines



CHEVY DURAMAX DIESEL 4340 BILLET H-BEAM CONNECTING RODS

- Designed for high strength and high quality at an affordable price



FORD 7.3L GODZILLA CONNECTING RODS

- Available in both PWR ADR and PWR ADR Plus versions for high boost and/or sprayed applications



PWR ADR PLUS CONNECTING RODS

- These rods are made for high boost and sprayed applications where maximum rod strength is needed
- Available in different lengths and configurations for small block and big block Chev, Ford, and Chrysler applications



CUSTOM FASTENERS



ARP has available stocks of all high strength materials, including Custom Age 625+, and our custom fastener manufacturing turnaround times are continuing to drop. Call us to discuss your custom fastener project.

ARP Fasteners are tested and proven in the most demanding environments on Earth...and beyond.

ARP fasteners are used in racing all around the globe and applications from space to below the earth's surface.



All ARP fasteners are manufactured entirely in our own facilities in Southern California and raced all over the world.

5,000 catalog items and specials by request

Special Orders +1.805.525.1497 • Outside the U.S.A. +1.805.339.2200

1.800.826.3045 • arp-bolts.com

OPTITORQUE TECHNOLOGIES

optitorque.com | 315-924-3888



TORQUEMASTER SS FASTENERS

- Providing performance that approaches the strength of Custom Age at a dramatically lower price point
- Available for popular domestic, import, and diesel stud and bolt applications for heads and mains, including aftermarket blocks
- OptiTorque fasteners are manufactured in the USA from domestic materials



TORQUEMASTER SERIES FASTENERS

- OptiTorque TorqueMaster is the go-to alloy for serious performance applications, offering the improved stretch area in its price class while increasing fatigue and clamping properties
- Available for popular domestic, import, and diesel stud and bolt applications for heads and mains
- Manufactured in the USA from domestic materials

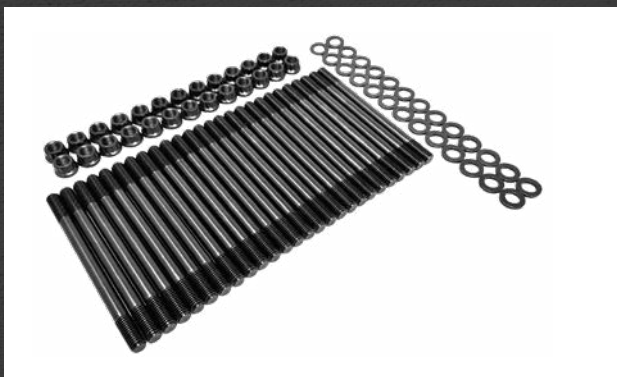

PATRIOT SERIES FASTENERS

- Provides a performance upgrade over OEM torque-to-yield fasteners
- Available for popular domestic, import, and diesel stud and bolt applications for heads and mains, as well as exterior and accessory fasteners.
- OptiTorque fasteners are manufactured in the USA from domestic materials



CUSTOM AGE FASTENERS

- OptiTorque Custom Age fasteners are for ultra-high-performance applications without compromise
- Features the company's proprietary processes and a corrosion-resistant tumbled finish
- Available for popular domestic, import, and diesel stud applications, including aftermarket blocks
- OptiTorque fasteners are manufactured in the USA from domestic materials

IT STARTS IN THE SHOP. IT ENDS IN VICTORY LANE.



Engine builders are perfectionists. And so are MAHLE Motorsport engineers. Expect unmatched performance, absolute tolerances and proven durability from every piston. And if you order a POWERPAK piston kit, you also get low-drag piston rings, clips and German steel pins—all designed to complement your pistons to ensure minimum friction and maximum horsepower.

POWERPAK



BUILD SOMETHING GREAT | MAHLEmotorsport.com

MAHLE
Motorsport

PACIFIC PERFORMANCE ENGINEERING

ppepower.com | 725-238-2002



AIR-TO-WATER INTERCOOLER KIT FORD 6.7L 2011-2023 POWERSTROKE

- High-flowing internal cores
- All-aluminum bar-and-plate-style construction
- 63% less restrictive than stock
- Reduces inlet backpressure, allowing turbocharger to operate more efficiently
- 50% larger core increases cooling efficiency
- Large, flow-optimized end tanks; increases charge air density
- Lowers exhaust gas temperatures



UP-PIPE KIT FOR FORD SUPERDUTY 2020-2023

- Full 304 stainless-steel up-pipes
- 50% larger flow path
- Reduced exhaust backpressure
- Better flow of exhaust gases
- Internally sleeved bellows
- Includes stainless-steel gaskets
- Direct bolt-on replacement
- Compatible with factory EGT and EBP sensors



ZILLA INTAKE TUBE, 2020-2024, CARBON FIBER

- Increased torque, better acceleration
- Faster throttle response, less turbo lag
- Reduces frictional pressure drop by 73%
- Increased volumetric airflow
- 100% dry/prepreg carbon fiber construction
- Works with OEM and most aftermarket airboxes
- Includes all necessary mounting hardware and new insulator grommet
- Available in two carbon fiber finishes

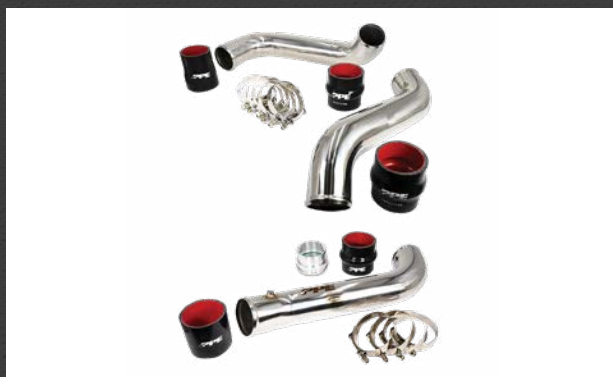

BOOST TUBE UPGRADE KIT FOR GM L5P 2017-2019

- PPE hot and cold side intercooler charge pipe kit
- Enhances performance and durability
- Full 304 stainless-steel construction
- 3.0-inch hot-side tube
- 3.5-inch cold-side tube
- Includes five-ply silicone couplers
- Improved air flow
- Enhanced throttle response
- Easy, bolt-on installation

PETERSON FLUID SYSTEMS

petersonfluidsys.com | 800-926-7867



R4 DRY SUMP OIL PUMP

- Lightweight design features aluminum rotors, shallow depth screw-in fittings and profile
- Rear drive setup standard allows for direct mounting of all popular steering/fuel pumps
- Four-lobe rotor is patent pending, twisted design for superior vacuum
- Superior oil pressure at high oil temps
- Unique and versatile mounting system
- Customized for unique applications



OIL TANKS

- Unique baffle system has been refined to provide the best deaeration performance
- Manufactured from spun aluminum and CNC-machined flanges and fitting for lightweight performance
- Custom configurations available



REMOTE FILTER MOUNT W/ ENGINE OIL PRIMER

- 20 psi in as little as 10 seconds using a standard cordless drill
- Utilizes an R4 twisted-lobe rotor design for quick delivery
- AN port fittings and tube, firewall or tank mounting options available



OIL & FUEL FILTERS

- Durable anodized billet body and end cap
- Wide variety of available accessory caps
- Pleated stainless steel or 10/20 micron filter elements
- Wide variety of available options for unique applications

PRECISION TURBO AND ENGINE

shop.precisionturbo.net | 855-996-7832



NEXT GEN 6466 TURBO

- 1,000-horsepower rating
- New Next Gen 7x7 CEA compressor wheel machined from a 2618-aluminum closed-die forging
- Next Gen Aero Technology, with flow enhancements to compressor housing to provide 10% more flow
- High-flow 66-mm turbine wheel
- 64-mm compressor wheel inducer
- Air-cooled, dual ceramic ball-bearing center section
- Easy, drop-in installation
- Lowers exhaust gas temperatures



NEXT GEN 6870 TURBO

- 1,200 horsepower rating
- CEA (Competition Engineered Aerodynamics) compressor wheel machined from a 2618-aluminum closed-die forging
- High-flow 70-mm turbine wheel
- 68-mm compressor wheel inducer
- Available with new SCP compressor cover with 4-inch inlet and 2.5-inch outlet
- Also available is HP compressor cover w/ 4-inch inlet and 3-inch outlet



NEXT GEN 7275 TURBO

- 1,380 horsepower rating
- Powerful 72-mm H cover turbocharger
- New CEA engineered compressor wheel machined from 2618 aluminum closed-die forging
- Air/oil-cooled opposed angular contact ceramic full complement ball bearing center section
- High-flow 11-blade turbine wheel design
- Proven to provide a 15% improvement over the previous generation



56-MM C02 PISTON-STYLE WASTEGATE

- A-347 stainless investment cast valve body ensures consistent performance without fatigue or failure
- Internal nickel chromium alloy valve
- Four individual ports
- Includes stainless-steel inlet and outlet flanges
- Includes all necessary clamps for installation
- Compatible with most aftermarket boost controllers for ease of use
- Warranted against manufacturer defects

VIEW SCALE DATA YOUR WAY

- ✓ TABLET
- ✓ SMARTPHONE
- ✓ RFX® INDICATOR
- ✓ PC OR LAPTOP

VISIT US AT PRI
BOOTH #1401



SW777RFX™ PROFESSIONAL Wireless Scale System
(PC, Tablet or Smart Phone Not Included)



ALL RFX® WIRELESS BILLET SCALE SYSTEMS FEATURE

Bluetooth® Communication from the Indicator to a Tablet or Device w/iRaceWeigh™

Scale Pads Manufactured from 6061-T6 Billet Aluminum

Field-Proven RFX® Wireless Weighing Technology

intercompracing.com

+1 763-476-2531 Worldwide



PROFORM PARTS (SPECIALTY AUTO PARTS U.S.A., INC.)

proformparts.com | 586-774-2500



LIGHTNING-BOLT 100 AMP MINI-ALTERNATOR; 10SI MOUNT (PART# 66437)

- Generates 80+ amps at idle; 100+ amps at top end
- 40% lighter than a 10SI: 7 lbs.
- 10si Direct Swap Billet aluminum adapter for 10SI mount (6.61-inch center-on-center)
- Perfect for drag strips and streets
- 12-volt, one-wire hookup
- V-belt pulley included; 5, 6, & 7 groove sold separately



SLIM-FIT RADIATOR SYSTEM DIRECT-FIT SERIES; 1964-1966 MUSTANG

- Slim-Fit Radiator System for 1964-1966 Mustangs
- Patented overflow tube with billet filler neck, tucked away for a sleek appearance
- Radiator + shroud + fan = under 4-inches thick
- Up to 40% thinner design than standard radiator/fan combo
- Hybrid extruded tube core tech with engineered louvers
- Pre-assembled: shroud, fan, adjustable thermostat
- Automatic and manual transmission models



WEDGE-LOCKING HEADER BOLTS; NICKEL PLATED FINISH

- Grade 8 Bolt's washers grip bolt head and header, creating wedge-locking action
- Vibration strengthens tension
- Bolt can be untightened, lubricated, and reused



PROFORM RACE SERIES CIRCLE TRACK CARBURETORS

- Circle track applications for gas, alcohol, & V8
- Features PROFORM's Next Gen high-flow carburetor main body, billet metering blocks, throttle baseplate
- Aluminum fuel bowl with sight-glass windows
- Dual pattern mount; dual-inlet with mechanical secondaries

BR *promag.com*

MSD MAG REPAIR

Only MSD Multi Mag Test Facility In The USA!

- Black Magic Conversions
- Complete System Dyno Load Testing
- Amperage & Magnet Upgrades
- Amperage Conversions
- Factory Authorized Repair Service
- Control/Spark Box Repairs
- Rotation Changes
- Circuit Board Rebuilds/Repairs
- Coil Replacements
- Factory Authorized Upgrades
- System Blueprinting
- Fire Damage Repairs
- Generator Servicing & Rebuilding

Congratulations to Paul Silva & Kyle Larson on their High Limit Championship!

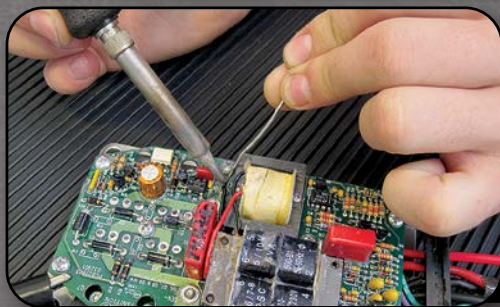

Generators, Point Boxes, Control Units, Connectors, Wire Harnesses & Every Other Part Your Pro Mag System will ever need!

Call for a FREE copy of the new BR Motorsports Super Parts Catalog!!



Engine Builder Programs • Quick Turn Around • UPS Daily Domestic Or Internationals

1-800-328-3333

2216 Mineral King Ave. • Visalia, CA 93292

REMFLX

remflex.com | 866-641-SEAL



PN 2008

- Remflex exhaust gasket set
- Fits GM LS engines with 1 7/8-inch round port
- Including 5.3L – 6.2L LS1, LS2, LS3, LS6 and L99
- Also 4.8L – 6.0L truck and Hummer
- Easy, drop-in installation
- Lowers exhaust gas temperatures

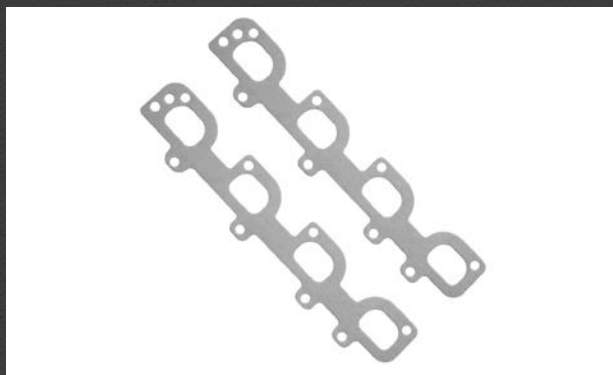

PN 6022

- Remflex exhaust gasket set
- Mopar V8 Hemi 5.7L (2009 & up)
- 6.1L (2005–2010)
- 6.4L (2012–2016) with oval/D-shaped port measuring 1-15/16 x 1-3/8 inch



PN 7009

- Remflex combination intake and exhaust for Toyota engines
- Fits L6 3.9L "F" (1969–1974)
- 4.2L "2F" (1975–1987)
- Stock-port Toyota Land Cruiser engine codes (F,2F)
- Heat riser and EGR gaskets Included
- Six-piece set

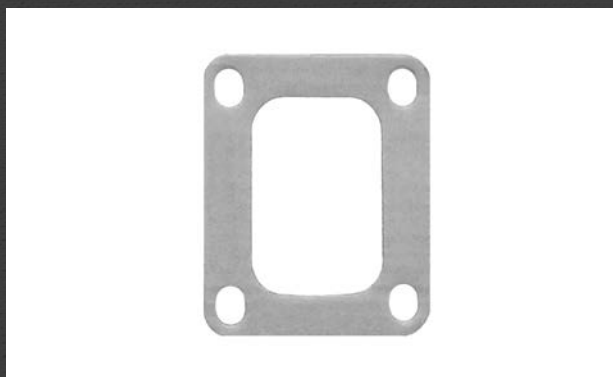

PN 18-006

- Remflex Turbo HD Inlet Gasket
- Fits Garrett, Greddy T4 inlet
- Four-bolt, turbo inlet/up-pipe gasket with open plenum
- 3- x 2-inch square
- Four elongated bolt holes
- Bolt spacing 3.250-inch on long side, 2.750-inch short side



MAHLE means performance.

Supporting the world's most powerful motorsports!

Across America, the drive to be the best perseveres in every person that dons a helmet and straps into the driver's seat.

That driver has enough to worry about in the few seconds of a run to think about whether his engine will make it the length of the track. The best engine builders trust only MAHLE products to perform every time. Drivers can focus from whether their engine is going to function correctly to putting up another "full pull".

MAHLE celebrates all of our partners in performance excellence – Team MAHLE. Loyal MAHLE supporters are encouraged to add a #TEAMMAHLE to highlight achievements on any track across all motorsports including sled pulling.

Visit us at PRI, booth# 1601 and check out our technical seminar on the schedule under PRI Education.



mahle-aftermarket.com

#TEAMMAHLE



SBI

sbintl.com | 615-248-6281



FORD POWER STROKE PERFORMANCE VALVES & SPRINGS

- Bimetallic design to improve overall durability
- Fully machined nitride austenitic material
- 6.0L, 6.4L and 7.3L
- Performance springs available for 6.0L and 6.4L
- Closed Pressure 84 @1.880
- Opened Pressure 230 @1.440



GM DURAMAX PERFORMANCE VALVES & SPRINGS

- Bimetallic design to improve overall durability
- Fully machined nitride austenitic material
- 6.6L 2001–2016 Duramax intake and exhaust performance valves application
- Nitride finish on performance springs increase creep resistance
- Closed Pressure 115 @1.614
- Opened Pressure 250 @1.064



CUMMINS PERFORMANCE VALVES & SPRINGS

- Bimetallic design to improve overall durability
- Fully machined nitride austenitic material
- Performance valves for 5.9L 12V, 5.9L 24V & 6.7L 24V
- Nitride finish on performance springs increase creep resistance
- Fits 5.9L ISB 24V & 6.7L ISB 24V
- Closed Pressure 110 @1.360
- Opened Pressure 159 @1.060



GM LS ROCKER ARMS

- Manufactured using a high-grade case steel with a captive bearing design. Eliminates factory bearing and powdered metal trunnion
- Stock and high-horsepower application

JONES

Racing Products.com



72 Annawanda Road • Ottsville, PA 18942-9702 • (610) 847-2028 (610) 847-8895

DIRT LATE MODEL

Dual-dowel front design allows pulleys to be added for race or dyno



Large billet crankshaft nut. Independent balancer bolt for strength & weight savings



Proper Belt Size Provided no tensioner is required increasing efficiency & reliability

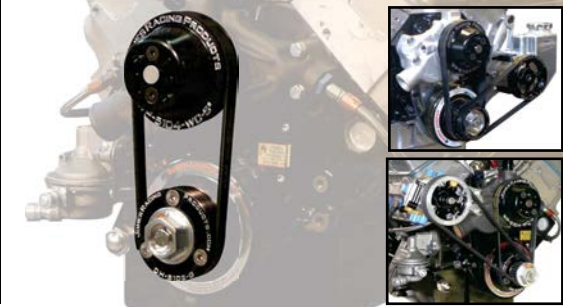

PS-9008-AL-AR

Lightweight Alum. PS Pump with Built-In High-Capacity Alum. Tank



Low Drag Asphalt

Positive-Engagement Radius Tooth Belt Drive w. Billet Aluminum Pulleys



High Capacity Fabricated Aluminum Power Steering Reservoir



Mini One-Wire Alternator 75 Amp High-Output 6 Lb. Lightweight Design

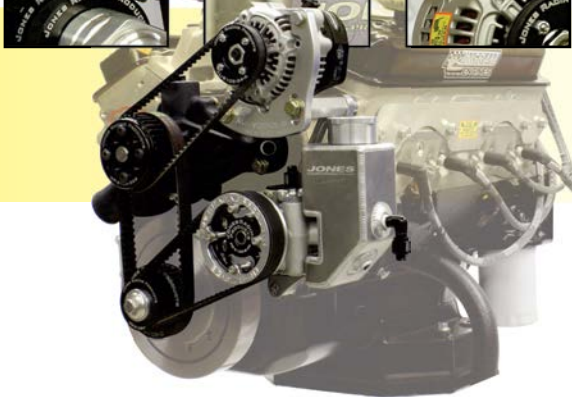

602/604 CRATE

SBC Circle Track Complete Front Drive

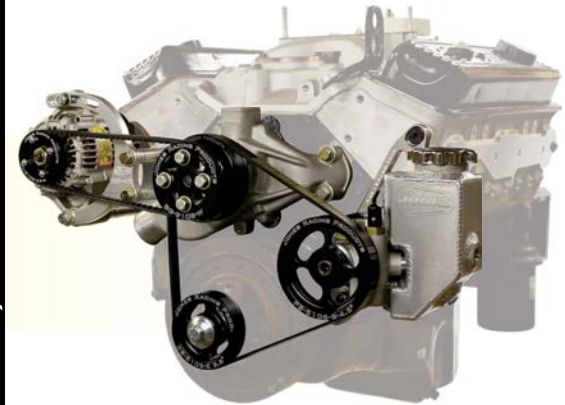

DIRTcar

Positive-Engagement Radius Tooth Belt Drive w. Billet Aluminum Pulleys



1/2" Thick Billet Alum. Bracket Supplied with Proper Length Billet Spacers & Hardware

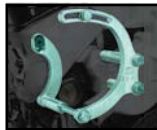

Mini One-Wire Alternator 75 Amp High-Output 6 Lb. Lightweight Design

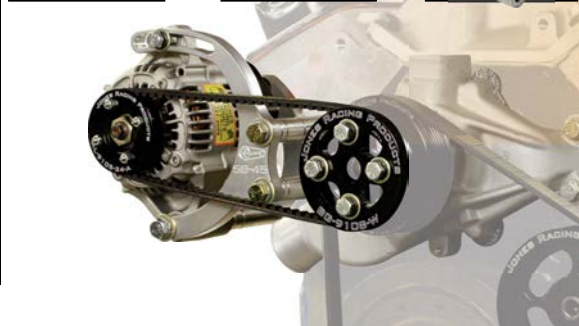

WP-9104-17-H3

Lightweight 3-Blade Fan



WP-9104-17-H3
Also available in:
14, 15, 16, 17, 18 & 19"



HUSTLER 3-Blade Fan

STAINLESS HEADERS MFG.

stainlessheaders.com | 800-290-3920



STAINLESS ZOOMIE HEADER KIT FOR BAE HEMI

- Complete fabricator's kit for building Zoomie headers on BAE 6x8X oval port heads
- Available in 2 3/8 or 2 1/2-inch OD, with 16ga or 18ga 304 stainless steel
- Optional upgrades include: CP2 Titanium upgrade (>50% weight savings), O2 sniffer kits, EGT sensor bungs, and even mirror polishing

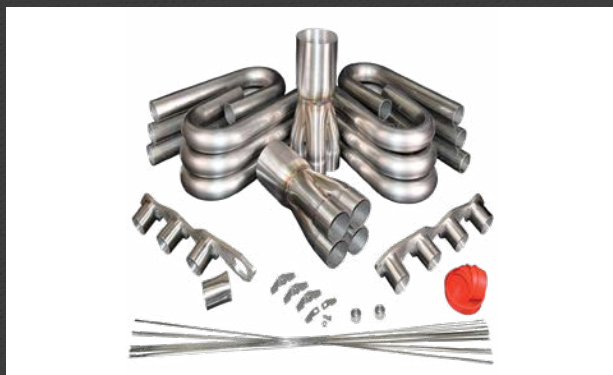

BIG BLOCK CHEVY HEADER BUILD KIT

- Available in 1 7/8-inch through 2 1/2-inch OD tube sizes
- Mild steel or 16ga 304ss
- Each kit comes with everything you need to build your own custom big block headers
- The best upgrade choice is our Performance Slip On Merge Collectors, drastically reduce build time and improve engine performance



OVAL LOW PROFILE MUFFLER

- Built for ground clearance without sacrificing performance
- Available in open chamber or three-chamber configurations
- We can custom build these for each individual's needs
- Offered with or without flanges, and different offsets are available
- Max height of only 4 inches means these are great for any build



TITANIUM 4-1 MERGE COLLECTOR

- Hand-crafted to meet each engine application
- Slip-on Performance collectors w/ built-in merge spikes
- The .050-inch CP2 Titanium construction means over 50% weight reduction from stainless
- Higher strength and excellent durability make these a must-have for performance headers

THE GOLD STANDARD FOR PERFORMANCE



ENERGY

**PRI BOOTH
4709**



**OUR CUSTOMERS COME FIRST - NOT INVESTORS ON WALL STREET
CALLIES PERFORMANCE PRODUCTS • WWW.CALLIES.COM • 419-435-2711**

TURBOSMART

turbosmart.com | 909-476-2570



TS-1 / TS-2 PERFORMANCE TURBOCHARGERS

- TS-1 oil cooled turbochargers
- TS-2 water cooled turbochargers
- V-Band, various T3 and T4 flange options
- Reverse rotation (selected sizes)
- Various AR's options
- Internal and external wastegate options available



STRAIGHTGATE76 3-INCH ELECTRONIC BUTTERFLY STYLE EXTERNAL WASTEGATE

- Zero-offset butterfly-style wastegate
- 76-mm (2.99-inch) butterfly-style zero-offset valve
- 723.7 CFM / 20.49m³ per minute flow
- Stainless steel (630) butterfly and shaft
- Stainless steel (347) main body
- Stainless steel (heat-treated 431) V-band clamps
- 360-degree mounting options on V-Band
- Clock-able actuator position (3 x 120 deg. options)



BOOSTGATE50 CHARGE AIR CONTROL VALVE

- Electronically controlled butterfly-style valve designed for charge pipe boost control
- Manufactured from billet aluminum for reduced mass
- Charge air control
- 50-mm (1.97-inch) butterfly-style zero-offset valve
- 383.9 CFM / 10.87m³ per minute flow
- Stainless steel (630) butterfly and shaft
- Billet aluminum main body



PROOPR RISING RATE OIL PRESSURE REGULATOR

- Rising rate oil pressure regulator for turbochargers
- Boost referenced, not unlike a fuel pressure regulator, and allows lower oil pressure at lower boost pressures and increases oil supply pressure to the bearing system at higher boost levels
- For large turbocharger systems and high-boost levels where additional pressure and confidence is required at high boost, high shaft speed, and horsepower levels
- Aluminum (6262 T6) anodized body and valve
- 1 x 1/8 NPT sensor / gauge port; 1 x 1/8 NPT boost reference port

2024 NEW PRODUCTS

BP BR X 18™

With the introduction of the NEW BP BR X 18™, BRODIX® has once again set the standard in the big block Chevy compatible market. Inspired by Pro Stock technology, the BP BR X 18 far outshines all others in its class. This head features a NEW 18° valve angle, designed to produce the maximum amount of torque and horsepower, in a conventional package. The intake port is raised .900 and amazingly flows over 535 cfm with a 2.500 valve! The exhaust port flows over 340 cfm through only a 1.830 valve! This head also has an extremely efficient 93 cc combustion chamber that is nitrous friendly. This head requires pistons, valve covers, shaft rockers, and an intake manifold specifically designed for the BP BR X 18. As always, these NEW heads come standard with all of the fine qualities that only BRODIX has to offer.

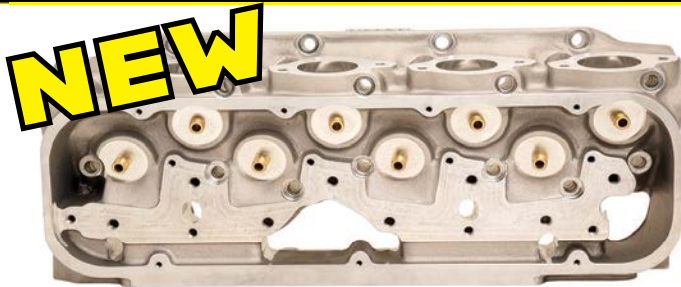

- Most Powerful Conventional Head on the Market
- 18° Valve Angle
- Intake Port Flows Over 535 cfm
- Exhaust Port Flows Over 340 cfm
- 2.500 / 1.830 Valve Sizes
- 100% CNC Ported
- Toughest Castings in the Business



NEW HD™ Sprint Block

HD™ 410 Sprint Block

8B 1000 HD™ / 8B 1050 HD™

- 8B 1000 HD: 400 Main / 4.125 Bore
- 8B 1050 HD: 350 Main / 4.125 Bore
- New Front Scavenge Location Eliminates the Need for External Tubes to Scavenge Entire Valley
- Front Oil Pressure Feed
- Fully Lightened



Sign up at www.brodix.com/signup to hear the latest and greatest news from BRODIX®!

WWW.BRODIX.COM



PROUDLY MADE IN THE USA!



Visit
www.brodix.com/shop
to see
BRODIX® apparel!



301 MAPLE AVE. P.O. BOX 1347 MENA, AR 71953
(479) 394-1075 • FAX: (479) 394-1996



ADVANCED FUEL DYNAMICS E-SENSE PERFORMANCE HI-FLOW ETHANOL CONTENT SENSOR

- Replaces GM/Continental content sensor
- Up to -12 AN fuel flow, with no restriction
- Reduced resistance, cooler fuel temps
- Interchangeable fittings: 5/16-inch, 3/8-inch, 1/2-inch m/f quick connect, -6, -8, -10, -12 AN threaded fittings
- Custom fittings available for large orders
- Billet body
- Made in the USA

Contact: 866-902-3835

advancedfueldynamics.com



AIR FLOW RESEARCH MAGNUM INTAKE MANIFOLD FOR BIG BLOCK CHEVY

- Seamlessly integrates with AFR Magnum Oval port cylinder heads
- Direct bolt-on solution for select AFR cylinder heads
- Dual-plane design
- Custom-tailored runners for high-horsepower applications, thriving in 1,800–6,200 rpm range

Contact: 661-257-8124

airflowresearch.com



APEXTURBO USA APEXTURBO APX 6266 EXTREME PERFORMANCE TURBOCHARGER

- Featuring the patented Dual Apex Wheel Technology advanced turbocharger technology
- Perfect for street enthusiasts and racers
- 62-mm compressor wheel / 66-mm turbine wheel
- Ball bearing
- Made in the USA

Contact: 734-777-1380

apexturbo.com

LOVE RACING? JOIN THE CLUB!



IT'S TIME TO BECOME A MEMBER!

WITH MULTIPLE MEMBERSHIP OPTIONS,
WE HAVE THE PERFECT ONE FOR YOU!



SCAN QR CODE
FOR MORE
INFORMATION



ARIAS PISTONS
ARIAS K SERIES HEAVY DUTY PISTONS

- Arias Pistons, whose name is synonymous with world record Honda engines, now expands its existing heavy-duty shelf offerings for the K series
- Made on heavy-duty 2618 forgings, with ultra-duty .250 wall pins, and heavy-duty rings
- This version offers a higher compression ratio and will be about 10.25:1 in a K20A or 11.5:1 with a K24A build

Contact: 310-532-9737
arias Pistons.com



ATI PERFORMANCE PRODUCTS
ATI SUPER DAMPER FOR FORD 3.3-3.7L V6 MUSTANG & RAPTOR

- Upgraded V6 Ecoboost damper replacing #HL3Z-6312-A
- Fits 2015-2017 Mustang, 2017-2020 Raptor
- 6.78-inch aluminum shell with six-groove and four-groove belt drives
- SFI certified, laser-etched timing marks, 3/16-inch keyway, heat-treated hub
- Reduces crankshaft vibrations
- Tunable, rebuildable and effective at all rpm

Contact: 410-298-4343
atiracing.com



ATM INNOVATION
XRB RACE SERIES CARBURETORS

- ATM's Gas XRB Series are our most versatile race carburetors with a 4150-style flange and "no vacuum ports"
- The perfect blend of a precision die cast aluminum ATM carb body with ATM two-circuit, four-emulsion billet metering blocks
- Available in five sizes from 650 cfm to 1050 cfm (4150 flange) applications

Contact: 270-846-3964
atminnovation.com

KEITH BLACK, INC.

THE LEGEND LIVES ON!

FHO
FOR HEMIS ONLY

Tim Banning at FHO has over 40 years of hemi engine building, design, and development. Producing in-house custom CNC block and heads, Billet intakes, custom oil system and valve train components, we have your hemi project covered from start to final dyno testing. Let us handle all your Hemi engine requirements.

FHO CNC
BLOCK AND HEAD
MANUFACTURING

727-386-5375

FOR HEMIS ONLY
forhemisonly.com

TIM BANNING
President FHO



FHO DYNO TESTING WITH
SUPERFLOW POWERMARK

VISIT OUR WEBSITE AT
keithblackhemi.com



AVIAID OIL SYSTEMS ENHANCED SERIES 2 DRY SUMP OIL PUMP

- New internals provide 12% improved through-put
- Available in three- through seven-stage configurations
- Compact design facilitates close-quarter installations
- Mounts available for most four-, six-, eight-, 10- and 12-cylinder engines

Contact: 818-998-8991
aviaid.com



AWA FORGED COMPOSITES PUSHRODS

- Our patent-pending pushrods are unique, lightweight, and durable options
- AWA uses proprietary processes and superior-grade materials to produce the finest pushrods while generating increased horsepower
- Our process allows us a quick turnaround and most sizes are readily available

Contact: 310-308-0024
awacomposites.com



BAT INC./MOCAL REMOTE FILTER MOUNT WITH THERMOSTAT

- Mocal remote oil filter stand/mount with oil thermostat
- Simplifies plumbing by incorporating oil thermostat into remote filter mount for use with oil coolers

Contact: 941-355-0005
batinc.net



ONE GOOD TURN
DESERVES ANOTHER



COME VISIT US AT **PRI** BOOTH 728



RACK & PINION CRADLE KITS

STEERING COLUMNS NEW LIGHT WEIGHT RACING COLUMNS NOW AVAILABLE!



FLOOR SHIFT
AND
COLUMN SHIFT!

THE MICROSTEER CUSTOM COLUMN PROGRAM



VISIT OUR
WEBSITE TO SEE
OUR CUSTOM
COLUMN FORMS!

UNIVERSAL JOINTS

BULLET-JOINT

DOUBLE U-JOINT
UP TO A 60°
ANGLE!

FOR MORE INFO VISIT OUR WEBSITE AT:

FLAMINGRIVER.COM

OR CALL US AT: **800-648-8022**



BEHRENT'S PERFORMANCE WAREHOUSE POLISHED ALUMINUM DOUBLE PASS RADIATOR FOR DIRT LATE MODELS

- 28- x 19-inch overall dimensions
- Polished finish
- Top right AN style inlet (accepts screw-in adapters)
- Lower right angled 1 3/4-inch outlet
- (1) 1/4-inch NPT, (1) 1/2-inch NPT, (1) 3/4-inch NPT (accepts screw-in radiator heater)
- 13.10 lbs. empty

Contact: 845-651-7389
behrents.com

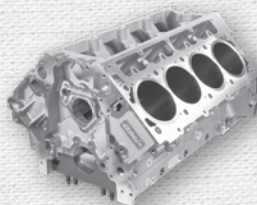

BILL MITCHELL PRODUCTS BMP LS CHEVY ALUMINUM ENGINE BLOCK

- Replaces Chevrolet LS1, LS7 or C5R blocks
- Cast from 357-T6 aluminum, the absolute strongest available, and has important improvements that even factory race blocks don't have
- Allows engine builders to obtain more power and enjoy improved reliability
- An advanced, precision-made block for LS applications

Contact: 386-957-3009
billmitchellproducts.com



BILLET CONNECTION/CLEARVIEW FILTRATION BILLET DRY-SUMP TANKS

- Dry-sump tank with ClearView See Through Filter on top
- Fully CNC machined—no welds
- Designed with superior venting and baffle system, which is mounted on top for easy maintenance

Contact: 509-467-7584
billetconnection.com



7 DRAWER MOBILE ROLLER CAB

THE BETA RSC24 IS THE EVOLUTION OF PERFECTION

The iconic C24S toolbox has evolved into the new beta rsc24, bringing racing character and high performance to your garage. Built in Italy using high-quality materials, it makes for a sturdy cabinet which will deliver a long service life. Below are the available accessories.

AVAILABLE ACCESSORIES & COLORS

- Perforated tool panel
- Computer bracket
- Folding shelf
- Paper roll holder
- Document holder
- Wood worktop
- 6 color options

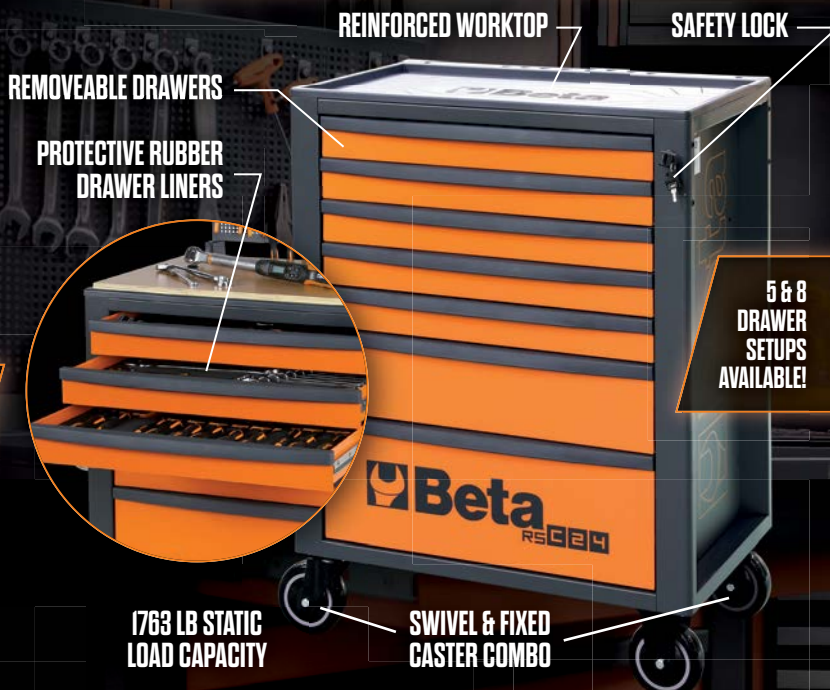

5 & 8 DRAWER SETUPS AVAILABLE!

Beta Tools USA is a subsidiary of BETA UTENSILI S.P.A. Sovico (MB) Italy

BETA-TOOLS.COM

1.717.449.5044



BLOWER DRIVE SERVICE SUPERCHARGERS, PULLEYS & BELTS

- BDS manufactures a complete line of new billet superchargers and components
- All in stock, ready to ship
- From 471-1471 Roots-style blowers
- From street to strip, we have what you need

Contact: 714-632-5678

blowerdriveservice.com



BLUEPRINT ENGINES BLUEPRINT ENGINES GM LS COMPATIBLE 376 C.I. PROSERIES ENGINE

- 549 horsepower and 469 ft-lb torque
- BluePrint Engines LS3 aluminum cylinder heads
- 10.7:1 compression ratio
- Hydraulic roller cam - .612 intake/.585 exhaust lift and 225 intake/238 exhaust duration @ .050 - 113° LSA - three bolt cam
- Hypereutectic pistons
- Nodular Iron crankshaft - 3.622-inch stroke and forged 6.125-inch rods

Contact: 800-483-4263

blueprintengines.com



BOELLINGER GROUP HOLDING GMH POWERTRAIN COMPONENTS

- Additive manufacturing
- Sand casting
- CNC machining of cylinder heads, turbochargers, compressors, crankcases, gearboxes, and suspension parts

Contact: 470-636-2923

boellinger-group.com

THE LEADER ...IN AQUEOUS PARTS CLEANING



Professional Racers Turn to ArmaKleen

The
ArmaKleen
Company™

safety-kleen®



ARMAKLEEN™ supplies only the highest quality environmentally sensible aqueous parts cleaning formulas and paint removing chemicals. Our innovative, patented cleaners are rigorously tested and designed for use in almost all commercial and industrial parts cleaning applications

ArmaKleen.com & ArmaKleen.com/Ask-Andy





**BRODIX
HD 410 SPRINT BLOCK**

- Models 8B 1000 HD and 8B 1050 HD
- New front oil scavenge location
- Eliminates need for external tubes to scavenge entire valley
- Front oil-pressure feed
- Fully lightened

Contact: 479-394-1075
brodix.com



**C&S SPECIALTIES
RACING CARBURETORS &
FUEL SYSTEMS**

- Designs, engineers, and manufactures blow-thru carburetors based on company technology and Aerosol Billet design
- Horsepower increases without changing your motor
- No intercooler required
- Simple bolt-on installation
- Potential power increases of 30–150%
- Available in all fuel types

Contact: 636-723-4996
candsspecialties.com



**CHAMP PANS
CIRCLE TRACK WET
SUMP FOR SMALL BLOCK
CHEVROLET**

- 41 years of experience of manufacturing quality, high-performance engine products
- Most oil pans come with a louvered windage tray for increased horsepower and better oil control
- You may see an increase of 10–40 pounds of horsepower depending on the style of oil pan and louvered windage tray

Contact: 715-834-7748
champpans.com

**HOT SHOT'S
SECRET**
POWERED BY SCIENCE

**#1 FASTEST
GROWING**

PERFORMANCE LUBRICANT BRAND IN THE U.S.A.
CHECK OUT THE EXPANDED **ADRENALINE®** RACING LINE

VISIT US AT PRI SHOW BOOTH# 4005

HotShotSecret.com 800.341.6516

AVAILABLE AT



CHE PRECISION TRUNNION UPGRADE KITS

- Hardened-steel trunnions
- Floating bronze bushings
- Applications: LS/LT, Ford 7.3L Godzilla, & Gen 4 and 5 Viper

Contact: 805-499-8885
cheprecision.com



COOLDRIVE AUTO PARTS EXCESS 1500CC FUEL INJECTORS

- Available for Corvette LS3, LS7, LS9
- Every set of Excess injectors includes eXact Match Data
- Tune files for 11 different ECUs
- Each file is adjusted to how your set performed on the test bench
- No two data sets are the same
- Lifetime limited warranty

Contact: 0400178755
ishop.cooldrive.com.au/



CRP CANTRELL RACING PRODUCTS CV780

- Oil filter block off plate
- Two hole in/out -10AN
- Most CV Products parts are back in stock

Contact: 864-580-1858
cvracingproducts.com

MANDREL BENDS



MERGE COLLECTORS



HEADERS



CUSTOM FAB



CNC MACHINED FLANGES

VIEW OUR CATALOG ONLINE



Race Engines

From 600cc - IOIScid

- Domestic • Late Model
- Import • Vintage

3/8" & 1/2" Thick Stainless,
 Carbon Steel & Titanium

SPD SPECIALTY PRODUCTS DESIGN INC.

888.778.3312

www.spdexhaust.com

Exhaust Engineering Excellence Since 1969



**DCM MANUFACTURING
MARADYNE SMART START FAN**

- 12 v PMDC (brushed) fan that provides features of BLDC (brushless) fans
- No PWM controller required
- Smooth and uniform starting
- Minimized amperage draw at start up
- Limits transient voltage
- Lower cost than BLDC fans

Contact: 440-666-5507
maradyneHP.com



**DEATSCHWERKS
DW810, 810LPH
BRUSHLESS FUEL PUMP**

- Provides high fuel flow in a reliable, quiet, and compact package
- Optimized impeller design achieves peak efficiency at target flow rates while careful engineering of internal fluid flow eliminates restrictions
- Brushless motor technology reduces friction and heat, vastly improving durability, especially when using aggressive fuels such as ethanol and methanol

Contact: 405-217-0701
deatschwerks.com



**ELGIN INDUSTRIES
ELGIN PRO STOCK**

- Elgin ProStock complete H/P valve train
- Featuring the legendary Sloppy Stage 2 camshaft and micro-engineered, surface-finished valve springs

Contact: 800-323-6764
elginind.com

UEM
PISTONS & RINGS®

**ANY ENGINE,
WE GOT YOU COVERED**

Meet **Brandon James**
Street Outlaw No
Prep Kings Camaro
PRI Booth#1251

ICD FORGED PISTONS | **KB** PERFORMANCE MOTORCYCLE PISTONS | **KB** HYPERTECH PISTONS | **TURBO** DIESEL PISTONS | **SINO** LITE

UNITED ENGINE & MACHINE | 1.800.648.7970 | www.UEMpistons.com





ENGINE WORKS ENGINE WORKS LS4000NR FORGED CHEVY LS1 CRANKSHAFT 4.000-INCH STROKE

- LS1 crankshaft
- 4.000-inch stroke
- 2.650-inch main journal
- 2.100-inch rod journal
- Six-bolt flange
- Forged 4340 steel
- No reluctor wheel installed (sold separately)

Contact: 423-391-0032

engineworksproducts.com



FASS DIESEL FUEL SYSTEMS DROP-IN SERIES DIESEL FUEL SYSTEM FOR 2017- 2024 L5P DURAMAX

- The Drop-In Series Diesel Fuel System was engineered to be the most effective filtration solution for the L5P Duramax
- This bolt-in fuel system removes over 99% of the water from diesel, along with air and debris down to two microns absolute

Contact: 636-429-7008

fassride.com



FLEECE PERFORMANCE ENGINEERING FREEDOM SERIES 6.0L POWERSTROKE CYLINDER HEAD

- Race-proven formula with hardened, oversized press-in valve seats provides maximum durability and longevity
- Fleece Performance exclusive single-piece O-ring design ensures complete combustion sealing vs. traditional stainless wires
- New valve springs
- New valves including Inconel exhaust valves
- No core charge or core to return

Contact: 317-286-3573

fleeceperformance.com

VISIT US AT PRI BOOTH #2001
GREEN HALL • INDIANAPOLIS, IN • USA | DECEMBER 7-9, 2023

TOP STREET PERFORMANCE is a supplier of high quality street and strip performance products. Our experience and alliances with a network of quality parts manufacturers allows us to offer an ever-expanding line of premium products at affordable prices, all backed by our one year warranty. With extensive offerings in ignition, cooling, electrical, intake manifolds, and more, we've got parts for everything from hot rod to LS. Whether you've got classic muscle or a fuel injected street rod, we've got the parts you need.

QUALITY. PERFORMANCE. PERIOD.

AIR & FUEL
DELIVERY



COOLING
& HEATING



DRESS UP



ELECTRICAL



IGNITION



LS & COYOTE



CONNECT WITH US!   

(562) 926-5858 | WWW.TOPSTREETPERFORMANCE.COM

TSP
TOP STREET PERFORMANCE

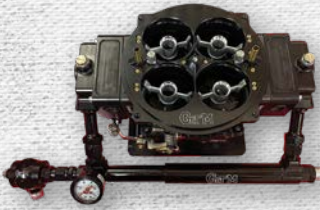

**GET'M PERFORMANCE PRODUCTS
BILLET 4-BARREL
CARBURETOR**

- All-billet carburetor
- Two-piece billet fuel bowls
- Billet metering blocks
- Proprietary Phillips-headed precision jets/air bleeds
- Get'm fuel log features Fragola fittings
- Get'm bypass regulator and liquid-filled pressure gauge
- Made in the USA and backed by superior customer support

Contact: 270-935-5334
getmperformance.com



**GREEN FILTER USA
HIGH PERFORMANCE AIR
FILTER 14-INCH ROUNDS**

- Washable, reusable, rechargeable
- Traps particles as small as five microns
- Increased air flow creates more potent air/fuel mixture
- Increased horsepower
- 14-inch rounds available in 2-inch – 6-inch heights
- The filter that racers demand

Contact: 724-430-2050
greenfilterusa.com



**HYLIFT JOHNSON
STOCK AND HIGH-
PERFORMANCE LIFTERS**

- Hydraulic and mechanical lifters
- Roller and flat applications
- Tie bar retro fit and lash adjusters
- Slow & fast leak down versions
- Patented EDM direct shot and dual float bearings
- Type ii material

Contact: 773-487-1400
toplineauto.com

**RACE-PROVEN
PERFORMANCE
SENSORS**



**INDUSTRY LEADING
FEATURES AND BENEFITS**



Visit Us At Booth #3744

Trenor.com | 949-576-0419 | 9781 Irvine Center Drive, Irvine, CA 92618



JESEL JESEL PRO TIE-BAR LIFTER

- Jesel Pro Tie-Bar lifter is perfect for racers in every type of racing venue
- Whether you are into drag, road, circle, or marine racing, they are designed to be the most durable available
- From .842 to .937 inches, these lifters can be ordered with either bushed or needle bearing rollers

Contact: 732-901-1800
jesel.com



KOTWICA ENGINEERING CRANKSHAFT

- Custom-made crankshafts
- One piece or small batches
- Billet crankshaft for any kind of engines

Contact: +54 11 4249 9379
kotwica-engineering.com.ar



KOWI AUTOMOTIVE CRANKSHAFTS

- Custom billet crankshafts for any kind of engine
- Capability for unique pieces or small batches

Contact: 980-938-4828
kowiautomotive.com

BURDICK'S

RV Center

We are the newest dealer for
RENEGADE, CLASSIC and XL Lines



UNITS ON ORDER, CALL US FOR DETAILS!



Renegade

ATC
WORLD CLASS TRAILERS

WWW.BURDICKSRVCENTER.COM
315-652-3764



**LATE MODEL ENGINES
VVT-DELETE FRONT COVER
BUNDLE**

- LME billet timing chain guide allows user to delete factory tensioner that may fail
- LME billet front cover allows user to delete factory cam phaser that may fluctuate at high rpm or boost levels
- Upgrades will improve overall performance and reliability

Contact: 713-849-4505
latemodelengines.com



**LPC ELECTRONICS
COMBUSTION ENGINE
INTAKE VALVE**

- This intake valve optimizes the airflow efficiency and mixture quality due to its aerodynamic design
- Creates airflow as equal as possible around the entire circumference of the valve
- The helical grooves provide heat dissipation and wear reduction
- Improve performance to naturally aspirated racing engines

Contact: 949-491-3988
usalpc.com



**M&M COMPETITION ENGINES
1SPEC EVOLUTION SBC
BLOCK**

- Cast iron SBC block
- STD or LT1 reverse cooling
- Deck heights 9.025-9.325
- .391 raised cam
- 4.400-4.500 bore center
- Wide "Rocket Block" pan rail
- Oil filter provision
- 55-mm roller or 60-mm babbit
- 350 or 400 main
- One- or two-piece rear main seal

Contact: 317-739-3187
mmcompetitionengines.com



Modular Steel Work Benches

- Work Surfaces from 32"x48" to 42"x90"
- Heights from 34" to 46"
- Static or Mobile: Bolt to Floor, Leveling Feet, or Caster Options
- Raw Mild Steel, 304 Stainless Steel, or Custom Powder Coat Finish
- Fully Gusseted 11G Steel Construction
- Capacity: 3,000 lb max with feet or 1,500 lb max with casters (evenly distributed)
- Made in USA

PRI Show Booth #3645
WCFab.com | 630-277-8239

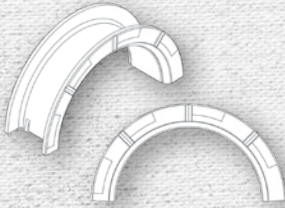

MAHLE AFTERMARKET CLEVITE F-SERIES ENGINE BEARING

- New standard for reliability with highest load carrying and thrust load ability
- Up to a 90% increase in load carrying capacity before seizure versus conventional copper/tin/lead overlay bearings
- Increase fatigue strength & wear resistance overlay
- Ramp and pad designed thrust face (when applicable)

Contact: 248-347-9712
mahle-aftermarket.com



NATIONAL PERFORMANCE WAREHOUSE EPG - ENGINE PARTS

- Full line engine components

Contact: 305-953-7270
npwcompanies.com



NITROUS EXPRESS UNIVERSAL MULTI-PUMP FUEL HAT

- Two-pump street-able configuration supports 1000+ RWHP on e85, up to 1300+ on gasoline
- Three-pump street-able configuration supports 1500+ RWHP on e85, up to 2000 on gasoline
- Three-pump race configuration supports 1600+ RWHP on e85, up to 2100 on gasoline

Contact: 940-767-7694
nitrousexpress.com

FiTech

PTFE

FUEL LINE KITS

EVERYTHING YOU NEED TO ASSEMBLE A HIGH PRESSURE FUEL LINE SYSTEM IN ONE KIT!

- Anti-Static Inner Liner
- Stainless steel mesh reinforces the hose for strength
- PTFE internal line handles all fuels, ethanol blends or alcohol
- Supplied with 12 -6 AN fittings, a 10-micron filter, check valve and line clamps

PTFE Hose Kits

20' Natural, PN 51005
40' Natural, PN 51007
20' Black, PN 51006
40' Black, PN 51008

Stainless steel hose

Anti-Static Inner Liner

Durable PTFE line

Fire Retardant Black Sleeve (black hose kits only)

951-340-2624
sales@fitechefi.com
FiTechEFI.com

3
YEAR
LIMITED
WARRANTY
FiTech
Fuel Injection



**NORTHERN RADIATOR
RACE RADIATORS**

- High-performance aluminum radiators
- Up to 24% improvement in heat transfer over other brands
- 16-inch and 19-inch styles with two rows of 1-inch high-capacity cooling tubes
- Single, double and triple pass options for optimum cooling
- Louvered cooling fins for better heat dissipation

Contact: 800-328-8900
northernradiator.com



**PERFORMANCE BEARING
CERAMIC BEARINGS**

- Premier hybrid ceramic bearing manufacturing company
- Produces, modifies and customizes ceramic bearings
- If you want to go faster and have less drag in your rotating assemblies, give us a call

Contact: 801-597-6950



**PERFORMANCE DESIGN
XS LS3 INTAKE MANIFOLD**

- Injection molded glass reinforced nylon construction
- Modular runners with three staggered lengths for best performance
- Billet fuel rails with external quick disconnect near stock location
- Carbon fiber center bolt cover
- 90-101-mm, 103-mm or 112-mm forward facing throttle body flange

Contact: 248-507-4885
performancedesign.com

Visit Us:
PRI
Booth
5667

*The Industry's Most Complete Line
of Engine Building Machinery!!*



**Fast
Accurate
Automatic**



CNC Boring Mill
ACF200 CNC



CNC Surfacer
RP1400 CNC

Comec, Inc.

www.comecus.com
info@comecus.com
800-887-6076



PERFORMANCE DISTRIBUTORS SLIP COLLAR RACING DUI

- Features a slip collar with 7/8 inches of adjustability
- Great if you have decked your heads or milled your block
- Ensures a precise installation, while preventing engine damage from the distributor being out of alignment
- Advance is curved on a distributor machine
- Comes complete, including the dependable Racing D.U.I. Coil and Dyna-Module

Contact: 901-396-5782

performancedistributors.com



POWERMASTER PERFORMANCE COYOTE PERFORMANCE ALTERNATOR

- Powermaster's HPR alternator for Coyote engines is available with an OEM clutch or solid pulley in CW or reverse mount CCW rotation
- Two direct-fit housings are available - 145/175 amp or 195/245 amp output - with one-wire or OE plug-in connection
- Available with 14.8-, 16.8-, 17.5- or 18.2-volt output for racing electrical systems

Contact: 630-957-4019

powermasterperformance.com



PROCHARGER SUPERCHARGER SYSTEMS F-4X-136

- F4X-136 introduced in 2023
- Quickly became favorite among top racers in No Prep Kings, Pro Mod and Radial Outlaw classes
- Contact ProCharger for more information on supercharger models for your racing needs

Contact: 913-338-2886

procharger.com

CNC Heads, Blocks, Parts

"One minute we are doing a cylinder head and 10 minutes later we have a block in the machine"

Tony Salloum,
VAC Motorsports

One Machine, One Fixture



Patent Pending



CENTROID

Performance Racing

Call (814) 353-9256 x101

www.centroidperformanceracing.com

Videos
Online!





**RACE WINNING BRANDS
WISECO RED SERIES
PISTONS**

- RED series pistons feature Race Engineered Design, offering strength, durability, and performance
- Forged 2618 material, designed for moderate to heavy-duty performance
- Hundreds of part numbers for popular domestic engines available off the shelf
- Supplied in kits with pistons, rings, pins, and locks

Contact: 440-951-6600
rwbteam.com



**RADIUM ENGINEERING LLC
FUEL PRESSURE
REGULATOR**

- Universal EFI fuel pressure regulator
- Exclusive "tool-free" pressure adjustment
- Directly mounts on fuel rail via swiveling fitting
- 360 degree positional vacuum reference fitting
- 15 to 100 psi (pump dependent)
- Dual 1/8 NPT ports for fuel pressure reading
- Multiple fittings provided for vacuum reference connection

Contact: 503-783-8850
radiumauto.com



**RON DAVIS RACING PRODUCTS
TITAN MARK 6 RACING
RADIATOR**

- All aluminum construction
- TIG welded
- Pressure tested to 32 psi to ensure 100% leak-free
- 6061-T6 1.25-inch diameter outlets
- Race-proven design

Contact: 623-877-5000
rondavisradiators.com

ROGERS-DABBS PERFORMANCE PARTS

WORKING FOR THE RACERS

We would like to express our gratitude to all our customers who have purchased with us. Additionally, we would like to extend an invitation to those who have yet to purchase to send us a copy of any quotes they have received from other vendors. We would be happy to see if we can offer a better deal and help save you some money.



RDC123.COM

1-855-946-7743

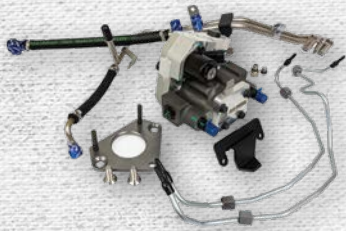

S&S DIESEL MOTORSPORT FORD 6.7L CP4 TO DCR PUMP CONVERSION

- More durable replacement for the CP4
- Does not require any ECU calibration
- OE fit and function
- Two-piston DCR high-pressure fuel pump
- Patented Eccentric Drive pumping tech
- Pressure-lubricated cam and bushings
- Corrosion-resistant inlet metering valve
- Fits 2011–2022 Ford F250–F750 diesel trucks
- SEMA Certified Emissions Compliant

Contact: 812-521-0123

ssdiesel.com



SCE GASKETS SCE GASKETS VULCAN CUT-RING CR580539R

- Cutting edge cut-rings with a hybrid composite design
- No machining required
- Releasing new engine platforms often
- Highlighting the Gen 3 Hemi Vulcan Cut-Ring

Contact: 661-728-9200

scegaskets.com



SPAL USA 16-INCH SEALED, BRUSHLESS, HIGH PERFORMANCE ELECTRIC COOLING FAN

- 16-inch flush mount style featuring a 500w brushless, high-performance motor
- Utilizes same mounting footprint as SPAL 16-inch, VA18 and VA33 brushed fans
- Rated at 2,433 CFM for optimal performance
- Works with SPAL "Plus" sensors
- IP6K9K sealed motor (waterproof/dustproof and water jet capable)

Contact: 630-336-5614

spalusa.com

BEND-TECH.

Versatile by Design.



THE MOST Versatile Plasma Cutter FOR TUBE & PIPE

Production Ready Technology for
Tube and Pipe Processing

Discover the A400
bend-tech.com/a400

Visit us at the PRI Show



SPEEDWAY MOTORS
**SPEEDWAY CHEVY SBC/
 BBC UNIVERSAL ALUMINUM
 RADIATOR**

- Custom fit for improved sound and comfort
- Professional quality, lightweight, all-aluminum racing radiator for any budget
- Furnace-brazed construction is more durable and improves performance vs. epoxy and gasket construction
- Two-rows of 1" aluminum tubes cool better than 5 rows of traditional copper tubes.
- Single-pass, cross-flow design with 2.25" core

Contact: 800-979-0122
speedwaymotors.com



STAINLESS WORKS
**2020-2023 GT500 LONG
 TUBE HEADER KIT**

- Improve the sound and performance on your Ford GT500 with premium headers from Stainless Works
- American-made and designed for the 2020-2023 Shelby GT500, these headers feature 2-inch or 1 7/8-inch primary tubes that are CNC mandrel bent to increase air flow and engineered to create power

Contact: 800-878-3635
stainlessworks.net



SWIFT FILTERS
FUEL & OIL FILTERS

- 40+ years of filtration experience
- Manufactured in the USA
- In-house engineering
- Technical sales help
- Don't gamble with inferior products, call us

Contact: 440-735-0995
swiftfilters.com



Rage
Series

VISIT US AT PRI BOOTH# 5509

**GEARED DUAL-ACTION
 POLISHER**

**LIGHTWEIGHT,
 LOW PROFILE**

precision balanced design
 delivers superior control

DUAL RUBBER SUPPORTS

provide incredible stability when
 the machine is not in use

RUBBERIZED DYNAGRIP

delivers reduced vibration and
 increased insulation resulting
 in greater operator comfort
 and reduced fatigue

RUNS 5" OR 6" PADS



20' SWIVEL CORD

SINGLE-ACTION LOCK TRIGGER

**ERGONOMICALLY-DESIGNED
 EXTENDED HANDLE**

for increased operator comfort during use

2 TOOLS-IN-1

Cuts like a rotary, finishes like a DA!

NEW

Model
DB8

THE PERFECT FINISH BEGINS AND ENDS WITH DYNABRADE

Dynabrade, Inc. | 1.800.828.7333 | dynabrade.com |



TI AUTOMOTIVE/WALBRO UNIVERSAL RECREATION ELECTRIC FUEL PUMPS

- Introducing TI Automotive's new Universal Recreation electric fuel pumps for UTV/ATV/SxS, snowmobile and motorcycles
- The turbine PWM capable or straight voltage pumps are manufactured in TI's Caro, Michigan USA facility
- 20 pump models including five E85 and 15 gas pumps, 75 LPH to 245 LPH, 37-mm diameter, and four electrical connector styles

Contact: 248-296-8872
aftermarket.tiautomotive.com

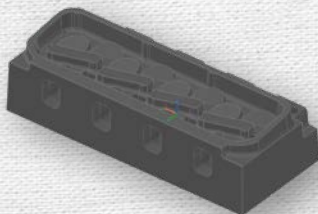

TITUS PERFORMANCE PRODUCTS SBF CLEVELAND CYLINDER HEADS

- Raised intake and exhaust ports
- Extended intake face for wider manifold selection
- Multiple port sizes
- 14 head bolts for maximum sealing
- Standard and non-standard valve locations
- Accepts stud or shaft-mount rocker arms

Contact: 301-932-9292
titusperformanceproducts.com



TOP STREET PERFORMANCE GEN V LT RETROFIT OIL PAN WITH FRAME CUTOUTS

- Low-profile retrofit oil pan for LT engine swaps
- Constructed from lightweight cast aluminum
- Designed for increased ground clearance
- Will fit many GM RWD applications equipped with small- or big-block engines and factory rear-sump pan
- Mounts perfectly to an LT engine
- Takes stock oil filter

Contact: 562-926-5858
topstreetperformance.com



TURBOSTART BATTERIES LT-16V

- 16-volt lithium-titanate race battery weighs only 12 pounds
- Compatible with any 16V charger
- Standard group 34 size
- Length: 10.24 inches; width: 6.89 inches; height: 7.16 inches

Contact: 865-394-6535
turbostart.com



XS POWER BATTERIES XS POWER LITHIUM TITAN8 RSV-S7-1600

- The 16-volt lithium Titan8 is the most user-friendly lithium battery on the market
- More cranking amps, reserve capacity, and amp hours than an AGM with no need for a special charger or special storage
- A truly plug-and-play lightweight lithium option

Contact: 865-688-5953
4xspower.com



BUILDING TRUST



FUELING PASSION

Our state-of-the-art facility performs at the highest level to serve our dealers with trust and passion. From the east to the west coast, and worldwide, Motor State proudly serves a variety of markets including Drag Racing, Engine Builder, Circle Track, Open Wheel, Modern Muscle, Circuit/Drift, Hot Rod, Early Muscle, Jeep, Truck, and Off-Road.

Become a Motor State Dealer. Visit our website and apply today.



SECTION

2

CHASSIS, DRIVELINE & SUSPENSION COMPONENTS

From building a race car to transferring power to the track, the following pages cover all parts related to the chassis, driveline, and suspension.



**TOOLGRID™
ORGANIZATION**



**BLACKLINE
ACCESSORIES**



**GARAGE &
TRAILER CABINETS**



**PIT CARTS
& TOOLBOXES**

TUNE UP YOUR TOOL STORAGE



PRI BOOTH #1925
EXHIBITOR BOOTH #2025



WWW.CTECHMANUFACTURING.COM | (715) 355-8842

AFCO RACING PRODUCTS

afcoracing.com | 800-632-2320



NEW AFCO 81 SERIES STOCK MOUNT GM FRONT AND REAR SHOCKS

- Designed for Southern Sport Mod, hobby stock, and street stock cars
- The new large body front shocks feature a newly designed 44-mm piston to reduce fade and minimize heat buildup. Multiple piston options are available
- Shorter front shocks allow lowering the front end of the car, improving stability and control



NEW AFCO 94 SERIES SHOCKS

- Addressing a clear need for a specialized base valve non-bulb shock that caters to the unique requirements of the stock car, sport mod, and B-mod shock tuner market
- Removable base valve for greater ease of tuning and customization
- Internal base valve design that allows the shock to run at a lower gas pressure
- Fully approved and legal for use in all sanctioning bodies



AFCO 1979-2014 MUSTANG DRAG STRUTS

- Fully independent compression and rebound adjustments for tailored performance
- Double-adjustable design for meticulous chassis tuning, click-by-click
- 35-mm piston diameter



AFCO TERMINATOR SPINDLE MOUNT STRUTS

- 46-mm monotube piston. Detent-metered adjustments ensure spot-on accuracy
- Three lengths cater to virtually all ride heights, fitting various chassis applications seamlessly
- Ideal for "No Prep" racing, "extra travel" models ensure better weight transfer for improved traction on challenging surfaces

ANDERSON COMPOSITES

andersoncomposites.com | 626-333-7024



TYPE-CR DRY CARBON FIBER HOOD FOR 2015–2020 FORD SHELBY GT350 & GT350R

- Track day inspired, improved heat extraction vent design
- Center vent measures 20" w x 23" l, side vents measure 8" w x 16" l
- Autoclave process with pre-preg 3K, 2x2 twill carbon fiber cloth, matte finish
- Weight savings, hood weight 20.8 lbs. (stock hood weighs 31 lbs.)



TYPE-OE DRY CARBON FIBER DOORS FOR 2015–2023 FORD MUSTANG

- Autoclave process with pre-preg 3K, 2x2 twill carbon fiber cloth, matte finish
- Doors include locations for factory glass, interior and accessories
- Weight savings, door weight 11.8 lbs. each (stock doors weigh 46 lbs. each)
- P/N AC-DD15FDMU-DRY



TYPE-OE DOUBLE-SIDED DRY CARBON FIBER HOOD WITH HOOD INSERT FOR 2017–2023 CHEVROLET CAMARO ZL1

- Dry carbon "skeleton" bonded to underside of dry carbon hood—reduced weight
- Autoclave process with pre-preg 3K, 2x2 twill carbon fiber cloth, matte finish
- Weight savings, hood weight 18.2 lbs. (stock hood weighs 32 lbs.)
- P/N AC-HD17CHCAMZL-OE-DRY



TYPE-OE DRY CARBON DECKLID FOR 2014–2015 CHEVROLET CAMARO

- Supports OEM style wings/spoilers
- Autoclave process with pre-preg 3K, 2x2 twill carbon fiber cloth, matte finish
- Weight savings, deck lid weight 7.2 lbs. (stock decklid weighs 21 lbs.)
- P/N AC-TL14CHCAM-OE-DRY

ANDERSON COMPOSITES

andersoncomposites.com | 626-333-7024

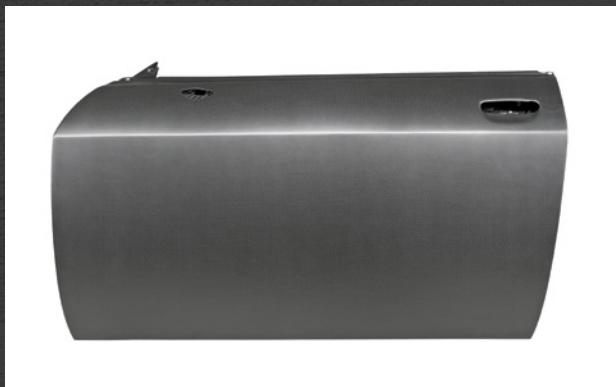

TYPE-OE DRY CARBON FIBER DOORS FOR 2015–2023 DODGE CHALLENGER

- Autoclave process with pre-preg 3K, 2x2 twill carbon fiber cloth, matte finish
- Doors include locations for factory glass, interior, and accessories
- Weight savings, door weight 12 lbs. each (stock doors weigh 50 lbs. each)
- P/N AC-DD0910DGCH-DRY



TYPE-OE DRY CARBON ROOF REPLACEMENT FOR 2008–2023 DODGE CHALLENGER

- Carbon fiber roof replacement, steel roof must be removed
- Autoclave process with pre-preg 3K, 2x2 twill carbon fiber cloth, matte finish
- Weight savings, roof weight 9.9 lbs. (stock roof weighs 24 lbs.)
- P/N AC-CR0910DGCH-DRY



TYPE-GT DRY CARBON FIBER HOOD FOR 2020–2023 CHEVROLET C8

- Endurance racing inspired vents, open to non-trunk area under hood
- Autoclave process with pre-preg 3K, 2x2 twill carbon fiber cloth, matte finish
- Weight savings, hood weight 9 lbs. (stock hood weighs 15.7 lbs.)
- P/N AC-HD20CHC8-GT-DRY



DRY CARBON FIBER REAR HATCH FOR 2020–2023 CHEVROLET CORVETTE C8 COUPE

- Mounts with OE hardware, glass not included
- Autoclave process with pre-preg 3K, 2x2 twill carbon fiber cloth, matte finish
- Weight savings, rear hatch weight 23.7 lbs. (stock hatch weighs 41.3 lbs.)
- P/N AC-TL20CHC8-DRY

AUTOMATIC TRANSMISSION DESIGN

autotransdesign.com | 262-251-7777



T400 BILLET REVERSE MANUAL VALVE BODY WITH TRUE SAFE NEUTRAL

- All-new true safe neutral circuitry prevents failure from direct drum overspeed
- Non-transbrake design for the ultimate in foot-brake class competition
- Low band apply and 1-2 shift accumulation for the best in transmission durability without sacrificing shift feel or timing



T400 BILLET 2-SPEED TRANSBRAKE WITH TRUE SAFE NEUTRAL

- Two-speed Powerglide pattern for Turbo 400
- True safe neutral circuitry prevents failure from direct drum overspeed
- Fast external transbrake circuitry you can rely on from a Hipster Brake
- Low gear uses planetary second-gear ratio, high gear is 1:1

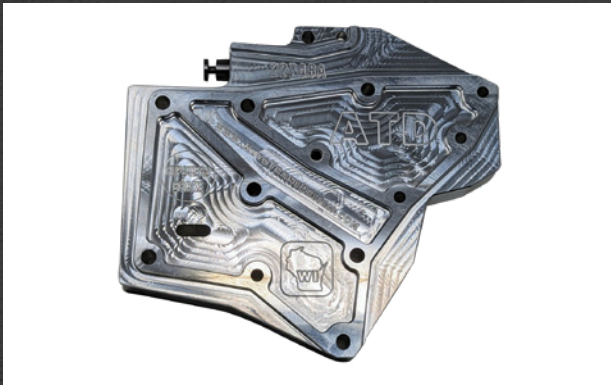

T400 BILLET TRANSBRAKE WITH ENGINE BRAKING

- Designed for drag-and-drive events
- Can be 3-2 downshifted safely
- Lightning-fast external transbrake circuitry
- Utilizes intermediate band for second-gear engine braking
- "Have your brake and drive it too!"



NEW BILLET TURBO 350 VALVE BODIES

- All-new lineup of billet aluminum Turbo 350 valve bodies is coming
- Transbrake, reverse manual, and reverse manual with engine braking models
- Featuring adjustable pressure regulation and improve filter pickup location
- Be among the first to see them at Booth 732
- Made in-house in the USA

CALVERT RACING

calvertracing.com | 661-728-9600



CALTRACS

- Patented Traction Bar system, axle above or below springs
- Hooks your vehicle, especially on hard acceleration
- Improves 60-foot times and consistency
- Keeps axle from rotating, maintains pinion angle
- Low-profile, racing, Monster configurations



CALTRACS TUNING WRENCHES

- Improved, stronger 5/16-inch thick steel
- Stress-tested, resists bending or breaking
- Designed to fit CalTracs jam nuts (1-1/8th socket)
- Sold as a pair to work together for easier torque adjustment
- Angled grip/short length fits in tight spaces



CALVERT RACING TIE DOWN BRACKETS

- Mounts on your CalTracs Rear Mount U-Bolts
- Easily secure the vehicle to hauler or trailer
- 1/4-inch zinc-plated steel resists corrosion or rust
- Available in 45-degree (fits all Standard and 1500 Truck CalTracs)
- 90-degree option also fits S10 CalTracs
- Sold as a pair, does not include straps



CR SERIES REAR SHOCKS

- Nine-way adjustable rear shocks
- Easily accessed external adjustment knob
- Steel twin tube design, heavy-duty 5/8-inch steel shaft
- Once dialed in, controls rear body separation for best traction on hard acceleration
- Keeps tires planted, controls rebound
- Maintain maximum consistency and performance

COKER TIRE

cokertire.com | 800-959-4500



PHOENIX REAR SLICKS

- Medium F9 compound for ultimate traction
- 28 x10.5 sizing for stock suspension drag cars
- Stiff sidewall (PH18S) popular for No Prep racing



M&H REAR SLICKS

- Slicks, drag radials available in many sizes
- New sizes 10.5-inch slicks for 17- and 18-inch wheels
- Popular DOT-approved Front Runner tires in stock



FIRESTONE WIDE OVAL RADIAL

- Proper sizing for 1967 through 1974 muscle cars
- Authentic sidewall markings and tread pattern
- Available in raised white letter and redline

FTI PERFORMANCE

ftiperformance.com | 386-736-5816



FTI POWERGLIDE CASE

- Built with entirely new internal parts – no cores
- FTI billet aluminum trans-brake valve body re-engineered springs, the Powerglide will not creep on the trans-brake
- Different power levels: Level 3 (1,000 HP), Level 4 (1,100 HP), Level 5 (1,500 HP), Level 5.5 (2,200 HP), Level 6 (3,000 HP)
- Powdercoat options: silver, black, black chrome, and carbon fiber



FTI TH400 BELLHOUSING

- Bolt-on aluminum bellhousing for a modified factory case
- Includes bellhousing, eight flange head bolts, one bell to pump gasket, two 1/8-inch plugs, SFI certified tag, and eight sealing rings



FTI 6R80 TORQUE CONVERTERS

- 6R80 Ford from 2011 to 2017
- Triple disc billet performance converter
- 9.5 inches
- Designed to handle boosted, naturally aspirated, and nitrous applications



FTI DIESEL TORQUE CONVERTERS

- Engineered for Cummins, Duramax, and Powerstroke engines
- Single or triple disc converters
- Billet steel covers, billet lock-up pistons, billet stators
- Low or extra low stall configurations

LONGACRE RACING PRODUCTS

longacracing.com | 800-423-3110



NEW LONGACRE ELITE PRO WIRELESS SCALES

- This feature-packed scale system includes a tablet and 15-inch x 15-inch low-profile, internal bridged pads with a sand-coated finish
- Ready to use out of the box with the new and improved Longacre Connect app for Android and iOS, offering free app updates
- Extended Bluetooth connectivity provides increased range in any setting



NEW LONGACRE ELITE WIRED SCALES

- This efficient and convenient scale system includes a control box and 15-inch x 15-inch low-profile, internal bridged pads with a sand-coated finish, ready to use out of the box
- Easily connect your pads to the control box using the included cables and link via Bluetooth to your personal device using the Longacre Connect app
- Control box displays all four wheel weights and cross weight



LONGACRE DIGITAL ELITE WATERPROOF GAUGES

- Engineered for wet and dirty environments, these gauges provide high-quality waterproof sealing and precise measurements with resistance to vibration, heat, and moisture
- Manufactured with IP-66 certified methods to be waterproof, dust tight, and safe against powerful water jets
- Gauges feature LED digital numbers and illuminated dial lights



LONGACRE SPORTSMAN ELITE GAUGES

- Reliable mechanical-style 2 5/8-inch gauges with built-in warning lights
- No external warning lights allows for less wiring and maintenance
- Once the gauge reaches the warning level, the background changes color
- Bright white background with a red needle makes them extremely easy to read
- Two wire hook-up for easy installation
- Legal in all forms of motorsports and classes

MCLEOD RACING

mcleodracing.com | 714-630-2764



MCLEOD BY PTT 7.25" CLUTCH KIT FOR LS

- Road racing, sand buggies, and land speed
- Low moment of inertia (faster acceleration, decreased brake wear on deceleration, quicker shifting)
- Available in 1-, 2-, 3-, or 4-disc configurations



MCLEOD RACING RXT TWIN DISC FOR NISSAN 400Z

- Nissan 400z application
- Handles 1,000 HP
- Ceramic-lined clutch discs will provide smooth engagement with a soft pedal effort



MCLEOD REVERSE MOUNT BELLHOUSING

- Aluminum bellhousing weighs approximately 9 pounds
- To be used with lightweight, button-style flywheels and a starter ring gear mounted on top of clutch
- Advantages: starter is mounted away from the heat of the headers, drivetrain will be mounted lower in the chassis, small overall size of the bellhousing fits in a stock car, and lower the vehicle's polar moment of inertia



MCLEOD BY RAYBESTOS 10R80 PERFORMANCE TRANSMISSION KIT

- One-stop-shop kit for 10R80 (2017 and up)
- GPZ friction clutch pack, steel clutch pack, transmission filter, piston kit, and performance overhaul kit
- Superior sealing capabilities, tighter seals, increased holding capacity, better flow and filtration, and 100% new bands

SILVER SPORT TRANSMISSIONS

shiftsst.com | 865-609-8187



SILVER SPORT GM MAGNUM

- TREMEC's Magnum double-overdrive 6-speed transmission
- 700 lb-ft. of torque with crisp shifts
- 1-1/8 in 26 spline
- GM LS with 2.66 1st or 2.97 1st
- .63 OD or .50 OD



SILVER SPORT STX SHIFTERS

- Bolt-on replacement for the stock shifter or available with shifter relocation kits
- Billet aluminum and steel components
- Double trunion design for high quality and durability
- Compact, short, positive, smooth, and fast



MASTER CYLINDER KITS

- Includes master cylinder, master cylinder mount, reservoir, pedal pushrod, and hardware
- Bore and stroke of master cylinder are .750 inches and 1.4 inches, respectively
- Available for Ford, GM, Chevy, and Mopar



4WD TRANSMISSION KITS

- TREMEC TR-4050 5-speed is geared for rock crawling and off-road lifestyle
- 6.16 1st and 6.03 reverse
- 600 lb-ft torque rating and available in three power level stages
- Kits include transmission, STX shifter, hardware, isolator mount, crossmember, and much more
- Kits available for manual upgrade or auto to manual conversion

SUNCOAST PERFORMANCE

suncoastperformance.com | 850-864-2361



TH400 BILLET TORQUE CONVERTER

- Zero-Drag Lockup Technology for constant oil flow, less parasitic loss, and quicker throttle response
- SunCoast Pro-Loc XL Sprag gives 15% increase in bearing roller surface
- Three-pass design for individual control of the converter circuit
- 7075 T6 billet aluminum plate versus round bar



10R80 BOLT-TOGETHER TORQUE CONVERTER

- Bolt-together design for easily replacing internals
- Zero-Drag Lockup Technology for constant oil flow, less parasitic loss, and quicker throttle response
- SunCoast Pro-Loc XL Sprag gives 15% increase in bearing roller surface
- Three-pass design for individual control of the converter circuit



SUNCOAST 10L90 TORQUE CONVERTER

- Bolt-together design for easily replacing internals
- Zero-Drag Lockup Technology for constant oil flow, less parasitic loss, and quicker throttle response
- SunCoast Pro-Loc XL Sprag gives 15% increase in bearing roller surface
- Three-pass design for individual control of the converter circuit



8HP70/90 SNAKE CHARMER

- Manufactured and tested in-house at SunCoast
- Has been 5.83 in the 1/8 and 9.09 at 149 in a 2018 Hellcat using the 8HP90 platform
- Both the 8HP80 and 8HP90 torque converters are available in a variety of stall speeds

Wireless. Accurate to 0.1 lb. Traceable through NIST.

Convert any scale system to Bluetooth® with our custom board integration.

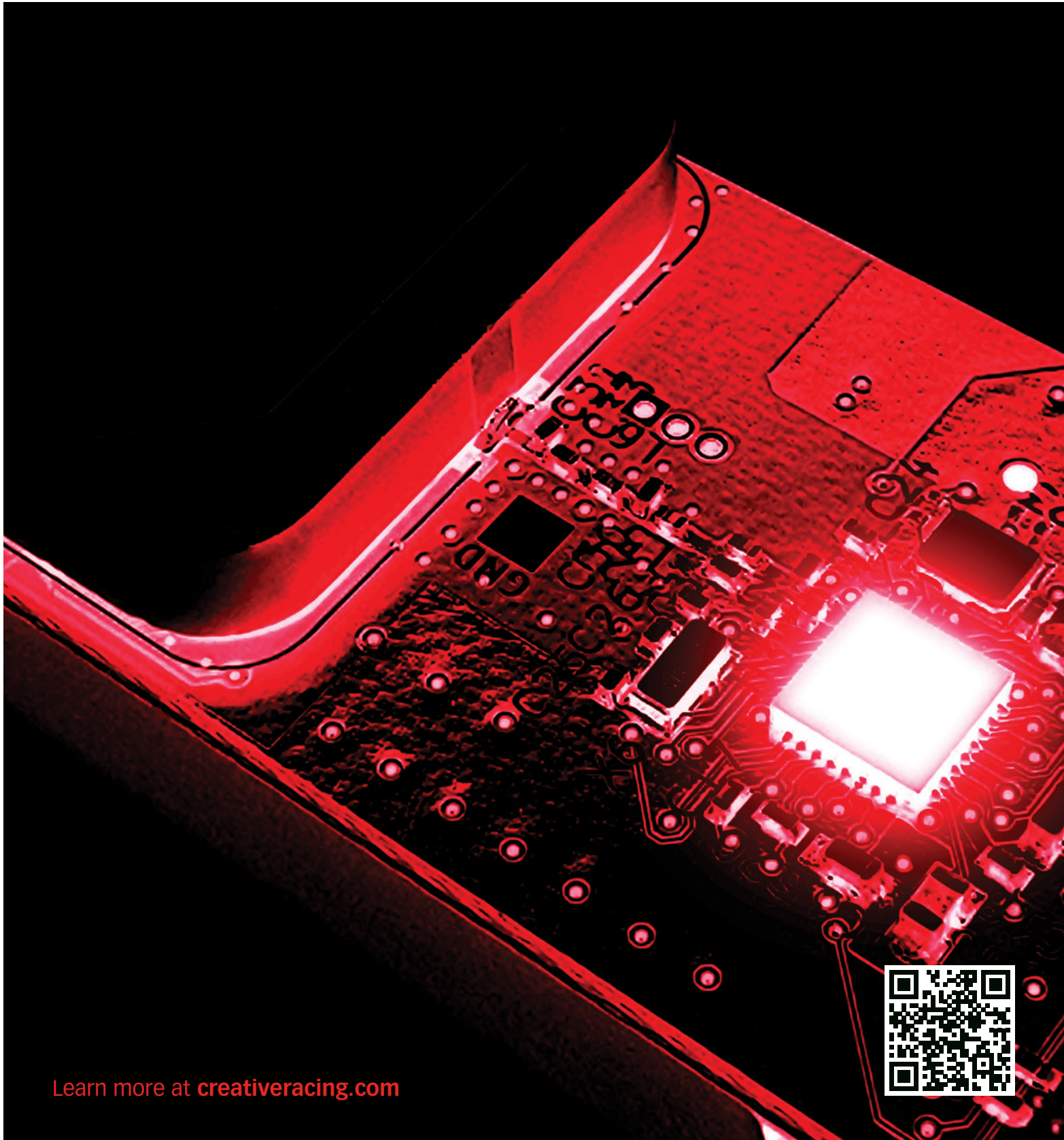

Learn more at creativeracing.com



ACC PERFORMANCE PRODUCTS PLUS BOSS HOG TORQUE CONVERTERS

- Manufacturing high-performance racing torque converters since 1970
- We build street, strip, racing, heavy-duty, no prep, outlaw, cruising, high-performance converters

Contact: 256-381-1965
accperformance.com



ADVANCED RACING SUSPENSIONS RACING SHOCKS

- Custom-built racing shocks for oval track race cars from quarter midgets to Late Models
- Each shock is built for the customer's race car and the race tracks where they are racing

Contact: 317-271-7100
advancedracing.net



ALDAN AMERICAN 1993-2002 4TH GEN CAMARO/ FIREBIRD COILOVER KITS

- RCX double adjustable coilover kits are now available from Aldan American for the 1993-2002 GM F-Body
- Convert stock front/rear suspension to fully adjustable coilovers with lowering capabilities of 0.0-2.0 inches
- Made in the U.S.A.
- 100% bolt-on design for easy installation

Contact: 310-834-7478
aldanamerican.com

BOOTH #1913

PRI 2023

RACINGFORCEGROUP

OMP

BELL
HELMETS

ZN
PERFORMANCE

Racing Spirit
The World's Best

+



www.bellracing.com // www.ompamerica.com



**ATL RACING FUEL CELLS
FIVE-GALLON SAVER CELL**

- Very popular five-gallon (20-liter) size
- Now offered with larger 6x10 fill plate
- Larger opening allows for easier installation of internal, such as collector unit
- Available with FIA hologram

Contact: 201-825-1400 or atl@atfinc.com
atfuelcells.com

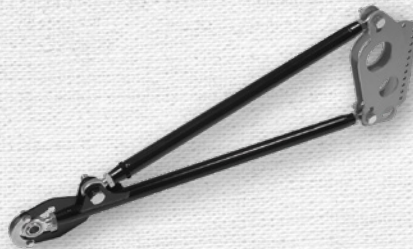

**CHASSIS ENGINEERING
OUTLAW LADDER BARS**

- Serious bars for serious power
- 1/4-inch laser cut brackets
- 1 3/8-inch moly tubing and moly hardware

Contact: 561-863-2188
chassisengineering.com



**CIRCLE D SPECIALTIES
CFD-DESIGNED BILLET
AIRFOIL STATOR
COMBINATIONS**

- Circle D Specialties brings CFD modeling to the forefront of torque converter design allowing truly unique, innovative, and virtually unlimited stator options
- Our billet-steel airfoil stators effectively widen the tuning window across converter platforms providing a competitive edge to hardcore racers as well as casual enthusiasts

Contact: 713-589-8664
circledspecialties.com



SERVING ALL OF YOUR ELECTRICAL, MECHANICAL,
METAL MANUFACTURING, RIGGING, AND HVAC NEEDS.



A Native American Owned
& Operated MBE & DBE Corporation

716.572.8969

DARANAHYBRID.COM





**DAYSTAR MACHINE & CYCLE
CONCEPTS
TORQSTAR**

- Motorcycle drag racing wheel

Contact: 336-984-7784
daystarmcc.com



**DRIVESHAFT SHOP
TESLA AXLES AND EV
CONVERSION**

- New Tesla Model 3 axles and Tesla rear drive unit 930 stubs
- Our stubs will allow you to adapt any 108-mm (930) CV to accommodate any EV swap or conversion axles
- Our Model 3 axles are rated to 800 hp and 3x stronger than OEM axles

Contact: 800-564-2244
driveshaftshop.com



**DRP PERFORMANCE PRODUCTS
PRECISION REAR-END
FIXTURE**

- Digital caliper readout
- Measure toe and camber to .001-inch
- Straighten tubes
- Measure side bells
- Measure toe change through pinion rotation

Contact: 540-483-4442
drpperformance.net

KEEP UP WITH PRI

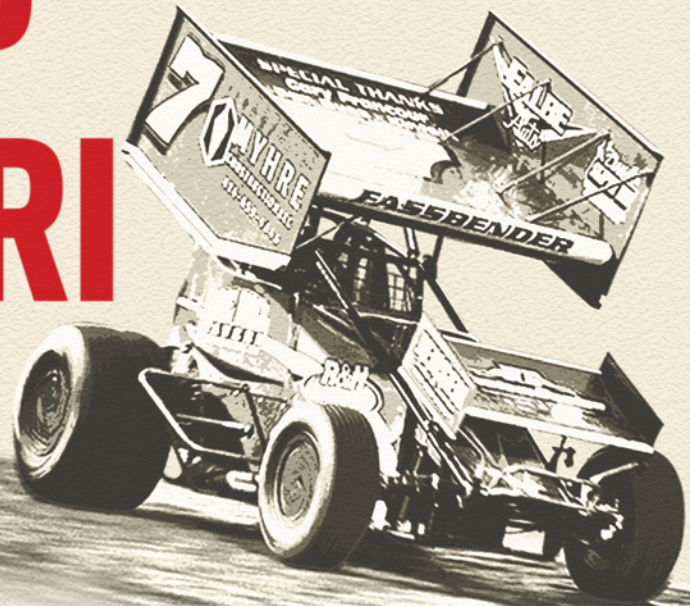

PRISHOW.COM/SOCIAL

PRI
PERFORMANCE RACING INDUSTRY



**FIVE STAR RACE CAR BODIES
TINTED RACING WINDOWS**

- Tinted windows are dark gray with 18% light transmission
- Made from exclusive optical grade materials
- Excellent hard coating applied to increase longevity
- Windows undergo our proprietary world-class custom-forming process
- Perfectly CNC cut to fit with beveled and countersunk mounting holes for a quick, easy installation
- Screen-printed black-out borders available

Contact: 262-877-2171
fivestarbodies.com



**GFORCE PERFORMANCE ENGINEERING
2015+ S550 & S650 MUSTANG
OUTLAW AXLES**

- GForce Outlaw axles for the S550 Mustangs were designed as high-performance half-shaft axles
- Now available for the new 2024+ S650 Mustangs
- From the road course to the drag strip and every road in between, these axles have been engineered for improved strength

Contact: 316-260-8433
gforce1320.com



**HOOSIER RACING TIRE
EXTREMECONTACT FORCE**

- ExtremeContact Force is a stylish ultra-high performance competition tire for both enthusiasts and professionals
- Ideal for endurance racing, this tire comes complete with SportPlus Technology, which provides responsive handling, better grip on wet roads, and extended tread life
- Consistent lap times
- Predictable on track
- Designed for dry and wet conditions

Contact: 574-784-3152
hoosiertire.com

FluidLogic

THE HYDRATION ADVANTAGE

**A 1% DROP IN HYDRATION
CAN LEAD TO A 12% DROP IN PERFORMANCE.**

The Answer: FluidLogic's Active Hydration™ system delivers the right amount of water at exactly the right time.

BOOTH 2033

**HYDRATION FOR THE HUMAN RACE
FLUIDLOGIC.COM**

©2023 RAINMAKER SOLUTIONS, INC. ALL RIGHTS RESERVED.



HOWE RACING ENTERPRISES HOWE PRECISION BALL JOINTS

- Provide low resistance, a captured ball for precise front-end alignment, and the largest selection of interchangeable stud sizes
- A proprietary process allows the stud to bend while the ball resists wear
- Made in the USA with fewer pieces and no plastic internal parts for superior durability

Contact: 989-435-7080
howeracing.com



IDIDIT IDIDIT PUSH TO CONNECT QUICK RELEASE STEERING HUB

- Aircraft grade aluminum
- Anodized black pull ring
- 3, 5, & 6 Bolt
- Smooth race style or GM/OE splined center
- With or without horn option on GM/OE style
- Fast and smooth engagement
- Push-to-connect without pulling the pull-ring
- Audible click when fully seated
- SFI certified

Contact: 517-424-0577
ididit.com



KEIZER ALUMINUM WHEELS 15-INCH SPRINT RR FORGED BL WITH TABS

- New forged billet components
- Re-designed lock & center
- Double wall rolled lip design
- Available in black and polished

Contact: 712-737-3053
keizerwheels.com



MOROSO



OVER 100 NEW PRODUCTS FOR 2024!

VISIT OUR WEBSITE WWW.MOROSO.COM OR VISIT US AT PRI TO DISCOVER MORE - BOOTH #4409!



Part No. 21167
Gen 3 Hemi, 6.2 Supercharged, Front Sump, Road Race Baffle



Part No. 68477
Pontiac V8, 301-455 Cyl. Head, Fabricated Aluminum, 3.5" Tall



Part No. 73740
Ultra 40 Wire, LS/LT, 9.75" or 11", with or w/o Heat Shields



Part No. 38779
Ford V8 289-460 (Except 351C) High Strength Chrome Moly Steel



Part No. 26218
Distributor Hold-Down, Billet Aluminum, SBC/BBC



Part No. 20539
Ford 351W, Front Sump, Road Race Baffle, Anti-Slosh Baffle



Moroso Performance Products, Inc.
80 Carter Drive, Guilford, CT 06437
203-453-6571 - www.moroso.com
Instagram & Facebook: @morosoperformance



RACE PROVEN
PERFORMANCE





**KING RACING PRODUCTS
BILLET SPRINT CAR FRONT HUBS**

- Made from aerospace 7075 aluminum alloy, manufactured to last
- Strong and super lightweight
- Removable hub seal design allows for inner bearing service without hub seal replacement
- Two-piece design makes parts easily replaceable

Contact: 559-636-1655
kingracingproducts.com



**OFFROAD ANONYMOUS
DIY ALIGNMENT PLATES**

- A good, quick, easy, accurate way to do an alignment on your rig yourself

Contact: 231-383-5664
offroadanonymous.com



**PERFORMANCE ENG & MFG
DIRT ONE-TON ALUMINUM
WIDE 5 AXLE TUBES FOR
QUICK CHANGE REAR ENDS**

- For the one-ton dirt late model aluminum tube quick change rear ends
- Newer one-ton snout for less flex on the newest style chassis from major builders
- Snout takes the larger one-ton bearings for the hub
- One-ton bigger snout for wide-five hubs (hubs must have one-ton race installed)

Contact: 636-629-6200
pemracing.com



Quality Isn't Expensive... It's Priceless!



SCAN THE QR CODE
TO VISIT OUR
WEBSITE!



email us!
websales@cheprecision.com

call us!
805-499-8885



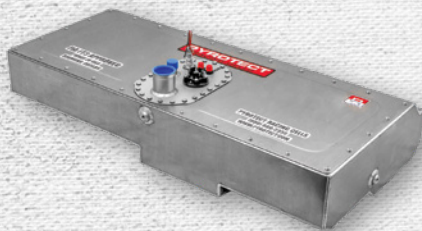

PYROTECT RACING CELLS CUSTOM FUEL CELLS

- Pyrocell Elite bladders are FIA FT3 approved
- Constructed from double-coated urethane fabrics
- Approved for all major racing associations
- Available for off-road, circle track, vintage, rally
- More than 25 years experience behind the products

Contact: 800-669-2355

pyrotec.com



QUICK PERFORMANCE 2007-2014 GM TRUCK FACTORY BRAKE AND ABS OPTIONS FOR FORD 9"

- New for 2023, now offering more options to be added to Ford 9-inch housing and axle packages
- Provisions to retain ABS on 2007-2014 GM Trucks (more models coming)
- Ability to run factory disc brakes
- Other six-lug brake kit options
- Wilwood, TBM, and drum brakes also available

Contact: 515-232-0126

quickperformance.com



RAYBESTOS POWERTRAIN LLC MUSTANG/CAMARO 10R80, 10L80 E CLUTCH TORQKIT

- Increases durability of the transmission
- Made with Raybestos GPZ material
- Manufactured with a higher quality of steel than the steel used on the OE design
- Reduces core temperatures
- Increases torque capacity
- Improves clutch life
- Full 15-tooth steel clutch plates to hold additional power

Contact: 800-686-4729

raybestospowertrain.com

Come see the newest "MOSER 9" HHD Housing



MUSCLEPAK

- Made here in the USA in Portland, Indiana
- Stronger, more affordable & fastest turnaround
- Available for most Stock & Custom applications



Introducing the Latest Brake Upgrade for Serious Racers!

- Unique rotor design to help control warping
- The most controllable drag brake on the market
- Stainless Steel/Brake Pad Combo that just works!



PRISHOW
DECEMBER 7-9, 2023, INDIANAPOLIS

Come Visit Us in Booth
#5037



RC COMPONENTS
F-5 ONE-PIECE FORGED BEADLOCK WHEELS

- One-piece forged billet aluminum, not welded
- Double beadlock
- 4- or 5-inch backspace options
- Available in polished finish or eclipse finish
- Both SFI 15.1 and 15.3 versions available
- Strongest wheels ever from RC

Contact: 800-360-0915
rccomponents.com



SCHULTZ ENGINEERED PRODUCTS
SCHULTZ RACING FUEL CELLS

- Full range of SFI 28.3 and NASCAR 2000 approved racing fuel cells, bladders, fill plates, drybreaks, and fuel pumps
- Offering standard size and custom fuel cells for all dirt, asphalt, road racing, offroad, marine and vintage classes

Contact: 845-742-9244
schultzproducts.com

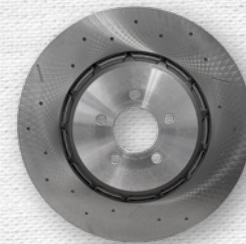

SHW GMH
TWO-PIECE LIGHTWEIGHT PIN BRAKE DISC FOR DODGE CHALLENGER & CHARGER

- One of the world's leading OEM brake disc manufacturers are now proud to offer the identical products, expertise, and service directly to the consumer
- True OEM replacement parts for many new performance vehicles
- Two-piece lightweight pin brake disc for Dodge Challenger & Charger: DFX41001, 390 mm x 34 mm, front axle

Contact: 949-255-5787
shw.de

DESIGNED TO OUTPERFORM EXPECTATIONS

Acura & Honda Performance.

xAxis™
Sealed Flex Joint



67475
Rear Camber Arm
(± 3.0° Camber)
2006-15 Civic



67465
CIVIC Camber Bracket
(± 1.25° Camber)
2006-15 Civic



67476
Rear Camber Arm
(± 3.0° Camber)
2016-22 Civic/Type R



Dial in rear camber angles with SPC's suspension tuning solutions. These rear camber arm kits provide adjustment without affecting wheel setback. xAxis™ sealed flex joints enhance handling while providing maximum camber dial in up to +3.0° for performance you will feel.

SPC
PERFORMANCE

Feel The Difference!

By Specialty Products Company®
©2023 Niwot Corp. dba Specialty Products Company®

1.800.525.6505

specprod.com





SLADE SHOCK TECHNOLOGY HEAVY DUTY PRECISION RACING SHOCKS

- A heavy-duty version of our high precision racing shocks
- Popular with bigger, heavier race cars, and teams on a budget wanting a more durable shock for the abuse from rough tracks and debris they encounter each week
- Features a 5/8-inch shaft and is available in non-adjustable, single adjustable and Copperhead double adjustable

Contact: 704-232-1127

sladeshocktechnology.com



SUPERIOR BEARING & SUPPLY WDT-30100 LOW-DRAG UTV BEARING

- Double-row tapered roller bearings instead of ball bearings
- Up to five times the life of a standard wheel bearing
- Has 2.5 times higher impact load rating over standard bearing
- Replacement for Polaris RZR and other models

Contact: 800-423-5318

superiorbearings.com



SWIFT SPRINGS USA 8-INCH MODIFIED FRONT SPRING

- Loads faster
- Better turn-in
- Requires less shock rebound
- Proprietary wire HS5TW
- Designed for USMTS, USRA & UMP Modified
- Part Number: 080-500-XXXF (600F shown)

Contact: 909-393-8623

swiftsprings.com



QUALCAST HEAVY DUTY
VALUE TRAIN KITS

PR1 BOOTH 5335



VALUE TRAIN
CYLINDER HEADS

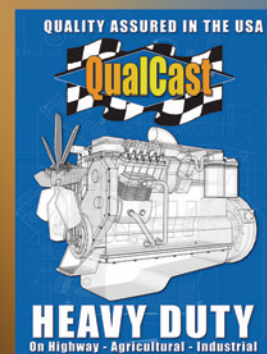

www.QualCast.com
888-432-4552





TURN ONE PERFORMANCE STEERING C5/C6 STEERING HOSE AND COOLER KIT

- Power-steering hose and cooler kit improves steering-fluid cooling
- Easy hose conversion to AN-6 braided lines
- Designed to mount in Z06 location on the cradle for easy access and good air flow
- Works with any C5 or C6 Corvette

Contact: 989-759-4206
turnonesteering.com



UB MACHINE SUSPENSION SYSTEM PARTS

- Tubular upper & lower A-frames
- A-frame mounts
- Panhard bars & mounts
- Monoball conversation kits
- Swedged steel tubes
- Clamp-on mounts, shock, weight, cone & plain clamps
- Brake brackets
- Wedge bolt (jack bolt)
- Battery box

Contact: 260-493-3381
ubmachine.com



We Have The Products Your Favorite Gearhead Wants This Holiday Season...
READY FOR DELIVERY!



SCS Gearbox



Probell



SCS 419-483-7278 GIFT CERTIFICATES AVAILABLE
SCSGEARBOX.COM • PROBELLRACING.COM
 739 W. Main Street, Bellevue OH, 44811



Like us!



CONNECT

PRISHOW.COM/SOCIAL





SECTION

3

RACING COMPONENTS, ACCESSORIES & SERVICES

Ancillary race parts complete the motorsports program, from helmets and drivers suits to computer software, trailers, and more, plus a variety of services.

DARTON SLEEVES™



**Great Product
Great Service**

Quick Turnaround on
Customs

We Always!!! Answer the
Phones When Called

Win With The Best in all
Categories Of Product,
Support & Quality

DARTONSLEEVES.COM

WEST: (800) 713-2786 or (760) 603-9895

EMAIL: sales@dartonsleeves.com

ASHCROFT INC.

ashcroft.com | 203-378-8281

ASHCROFT
Trust the shield.®

S1 PRESSURE TRANSDUCER

- Designed for high-volume manufacturing with high-quality, low cost and quick lead times
- All stainless-steel, thin-film pressure CVD-based sensor technology for exceptional cycle life and repeatability
- Outstanding shock and vibration resistance
- IP65 and/or IP67 levels of ingress protection



G2 AND G3 PRESSURE TRANSDUCERS

- G2: Field-proven sensor; all stainless-steel wetted materials provide excellent overpressure capability and durability
- G3: All 316L stainless steel wetted materials for installations in pressures as low as 100 in. H2O
- Both G2 and G3 highly configurable with wide selection of pressure connections, outputs, and electrical terminations



GV PRESSURE TRANSDUCER

- All-welded sensor and pressure connection designed for high vibration applications
- Field-proven polysilicon thin-film pressure sensor provides excellent overpressure capability and outstanding durability despite substantial shock and vibration
- Highly configurable with wide selection of pressure connections and electrical terminations



DG25 DIGITAL PRESSURE GAUGE

- All-welded sensor and pressure connection provide reliable vehicle support in pit lane
- Available in a wide variety of pressure ranges, connections and optional features, including backlit display and rubber protection boot
- Provides menu-driven features including unit select, min/max hold and dampening

AUTOROD CORPORATION

autorod.net | 732-851-5095



SENSOR INTEGRATION MODULE - ECU

- Simplify EFI sensor wiring for up to eight sensors
- The ARC SIM-8 allows eight sensors to be wired neatly back to the ECU as well as providing sensor power and ground

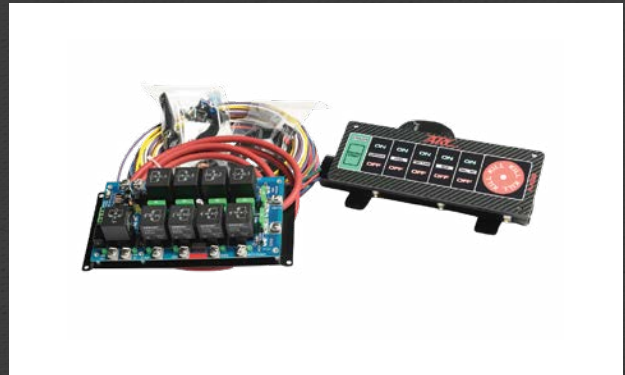

6001Z

- Our latest control module
- 40 AMP replaceable relays
- Separate fuses for each circuit
- Super bright LED for open cockpit cars
- 6-second computer shutoff delay
- Dedicated computer circuit
- Automatic low oil pressure shutdown
- Built-in neutral safety circuit
- Built-in bump start button circuit
- Built-in LED interior lights

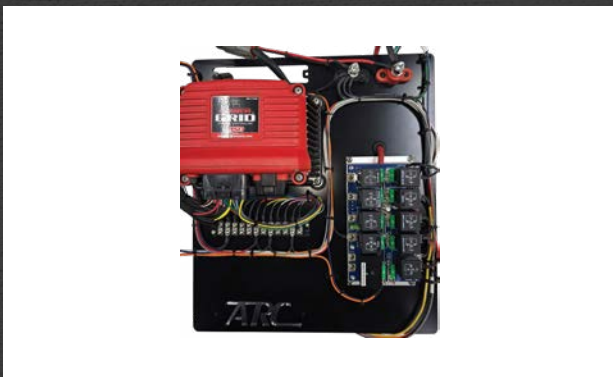

PRE-WIRED ELECTRICAL PANELS

- Take all the guessing out of building an electrical panel for your race car
- Through years of experience, we offer CAD-designed panels built for your car and for all the electronics that you need mounted
- This panel is wired to the point of installation in the car. All connections are made on the panel when it ships
- We also sell just a panel with no wiring



SENSOR INTEGRATION MODULE - ECU

- Simplify EFI sensor wiring for up to eight sensors
- The ARC SIM-8 allows eight sensors to be wired neatly back to the ECU as well as providing sensor power and ground
- This unit includes four ground triggered relays

DESIGN ENGINEERING, INC.

designengineering.com | 440-930-7940



GEN3 TURBO SHIELD

- Best turbo shield on the market
- Advanced textiles, and diving deep into what is needed to control turbo heat
- Silicone-coated outer layer
- Multiple stainless-steel and silica inner layers
- Stainless-steel mesh inner lining to prevent shield becoming brittle
- Strongest, most durable and most heat-resistant shield available



RFI BLOCKER SPLIT LINE SLEEVE

- Split-design self-closing shielding sleeving designed for high-performance EMI shielding of wire and cable bundles
- Reduces EMI and RFI interference that is common around automotive ignition systems
- Includes 17.5-inch grounding strap
- Sold in 3-foot lengths

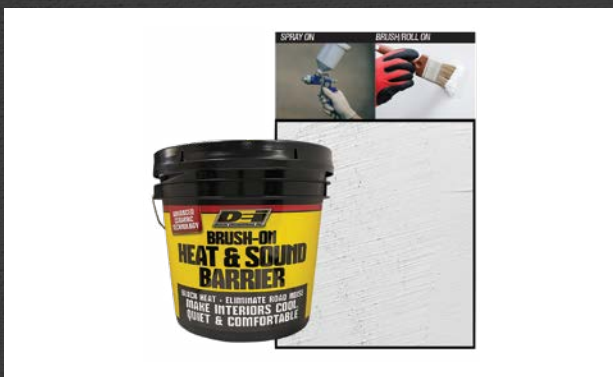

THERMAL & ACOUSTIC PAINT ON BARRIER

- High-tech paint-on thermal barrier
- Brush-on, roll-on or spray-on
- Creates thermal barrier on floors, walls and more
- Has acoustic properties and improves interior sound
- Environmentally friendly formula
- Comes in one-gallon pail



EV FIRE BLANKET

- Safety cover for Lipo battery fires
- Gives time to remove driver and protects safety workers
- No burn through for 30 minutes
- EV Lipo battery barrier—use between battery and vehicle
- Four hand holds and measures 46.5 x 46.5 inches

EAT SLEEP RACE

eatsleeprace.com | 732-921-4547



FUTURE RACE CAR DRIVER BOOKS: BOX SET

- This set includes all three award-winning board books for future racers
- Included: ABC Book For Future Race Car Drivers, 123 Count with Car Parts Book, and Colors Book For Future Race Car Drivers
- Free bonus: 4- x 4-inch "Future Racer On Board" car decal

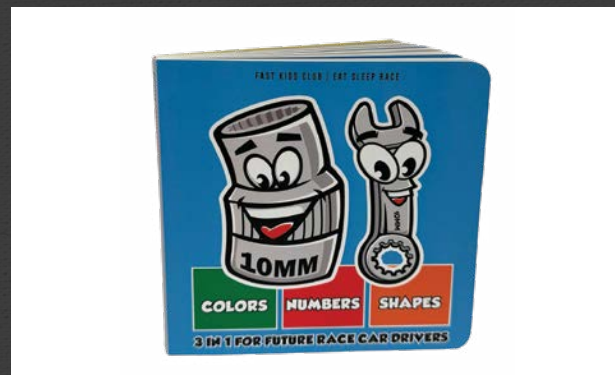

COLORS - NUMBERS - SHAPES: 3-IN-1 FOR FUTURE RACE CAR DRIVERS BOARD BOOK

- Teach colors, numbers, and shapes and encourage learning with our board book full of auto related illustrations

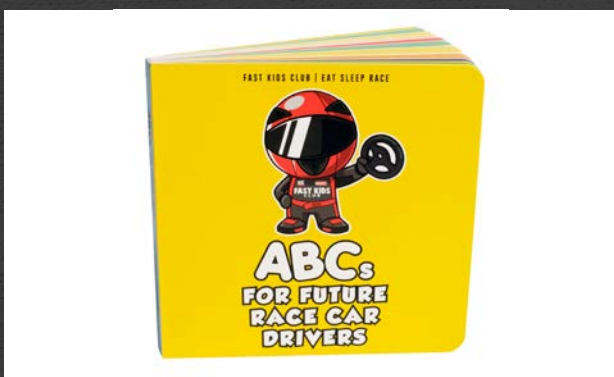

ABCs FOR FUTURE RACE CAR DRIVERS BOARD BOOK

- Award-winning board book
- Teach the ABCs and encourage learning with auto related illustrations

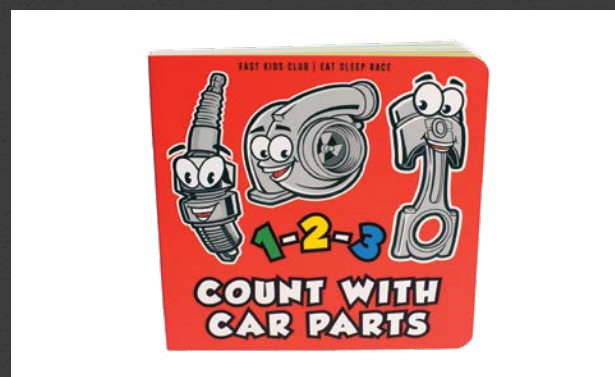

1-2-3 COUNT WITH CAR PARTS BOARD BOOK

- Award-winning board book
- Teach to count and encourage learning with auto related illustrations

ELITE TUNED SCHOOL

elitetunedschool.com | 727-741-2637



INTRODUCTION TO EFI TUNING

- This course focuses in on all the fundamentals of electronic fuel injection (EFI)
- You'll learn what is required to tune vehicles and begin to learn basic concepts surrounding tuning directly from industry-leading professionals
- Learn what software is necessary, how to download/install it, and how to begin working with your scanner



GM GEN 5 ADVANCED COURSE

- This course focuses on the LT1/LT4 advanced engine settings for E92/E92A ECUs
- Some important topics covered are advanced spark strategies, virtual torque manipulation, race fuels (including E85/C16/MS109), advanced fuel systems (including secondary port injection/DI pumps/SOI/EOI), what to look for when logging, and how to make it all work



FORD S550

- Uncover the secrets of the S550 platform with 46 videos and over 11 hours of content
- This course covers the Coyote, GT500, and GT350 from basic all the way to advanced strategies
- The most comprehensive and all-inclusive Ford course to ever be built



ELITE TUNED SCHOOL HP TUNERS MASTERCLASS

- Interested in learning how to tune using the HP Tuners software?
- Elite Tuned School's 6-week Tuning Masterclass offered exclusively through the University of Northwestern Ohio teaches you to master the fundamentals of tuning principles (including fuel, air, and spark), and learn to build/modify tune files for maximum power and efficiency dampening

H-P PRODUCTS

h-pproducts.com | 330-875-5556



CUSTOM BENDS

- Our custom bends are made-to-order based on customer needs and specifications
- Whether it's compound bending, tight-radius, one or multi-dimensional
- Bending capabilities range from 5/8-inch OD through 6-inch OD tubing utilizing CNC Rotary Draw bending, and through 10-inch OD using NC Rotary Draw bending



METAL ELBOWS

- Available and readily stocked in various material types, diameters, and degrees of bends (30°, 45°, 60°, 90°) with custom tangents available on request



WELDED FABRICATIONS

- Available and readily stocked in various material types, diameters, and configurations such as laterals, WYEs, TEEs, Ys, and more



CUSTOM TUBE FABRICATIONS

- Our made-to-order tube fabrications can include bending, end forming, laser cutting, and welding in order to meet customer needs and specifications

MAXIMA RACING OILS

maximausa.com | 619-449-5000



STEP 1: ASSEMBLY LUBE

- Lubricant designed to form a durable protective film on moving components
- Formulated with 2X Zinc anti-wear system that activates at both high and low temperatures
- Prevents metal-to-metal contact after startup
- Non-foaming formulation easily dissolves into both mineral and synthetic oils



STEP 2: ASSEMBLY GREASE

- High-performance assembly grease that excels in a multitude of heavy- and light-duty applications
- Unique calcium sulfonate complex soap thickener combines with a proprietary additive system to deliver thermal stability and extreme pressure performance
- Oil-soluble formulation won't clog filters and provides protection against corrosion, water washout, and wear



STEP 3: PERFORMANCE BREAK-IN OIL

- Mineral-based engine oil specifically formulated for breaking in engines with flat tappet camshafts, roller elements, and where maximum anti-wear performance is needed
- High ZDDP formulation combines the highest quality mineral base stocks with a shear-stable polymer system to provide fast and effective ring seal
- Proprietary additive system utilizes a complex, low temperature activating 2X Zinc system that ensures immediate and lasting protection



STEP 4: CHOOSE YOUR LEVEL OF PERFORMANCE

- Mineral-based engine oil developed formulation utilizes a 2X Zinc system combined with stay-in-place chemistry for protection during every run
- Semi-synthetic, ester-based engine oil designed to ensure optimum protection and peak performance for race and hot rod engines
- Full-synthetic, triple ester racing engine oil designed to ensure maximum performance while providing maximum protection under the most severe conditions

METALLOID CORPORATION

metalloidcorp.com | 269-503-7300



METCOR 57

- Solvent-based corrosion preventative
- Offers long-term indoor protection and is fast drying, water displacing and non-staining
- Deposited dry film 'seals off' metal surfaces from moisture and humidity on contact
- Ideally suited to protect corrosive-sensitive metals and alloys



ACCROLUBE HIGH-TEMPERATURE POLYUREA GREASE

- Effectively lubricates at temperatures as low as -50-degree F to over 600-degree F
- Provides extended protection against rust in moist environments and won't migrate from hot surfaces
- Reduces or eliminates maintenance downtime periods
- No mess or contamination
- Can reduce grease inventory



METALLOID1 BRAKE/PARTS CLEANER

- Ultra-fast drying, no residue, cleaning solvent intended to degrease any non-painted metal surface
- Instantly removes oil, dirt build-up, varnish, sludge, grease and brake fluid
- Contains no chlorinated solvents and is 50-state compliant
- Powerful spray breaks through even the toughest deposits



METALLOID1 BIOWELD ANTI-SPATTER SPRAY

- Reduces downtime due to spatter build-up and provides instant shielding action
- Will not affect surfaces to be painted
- Highly heat resistant
- Applied as directed, this spatter inhibitor is flow proof and will not spread beyond the point of impact

PERFORMANCE PLUS GLOBAL LOGISTICS

pplusglobal.com | 636-946-7587



LOGISTIC SOLUTIONS

- Official logistics partner of the performance industry
- We manage logistics needs of customers with the highest quality service at competitive prices
- Performance Plus mission is to exceed customer expectations by providing 'Best in Class' custom solutions
- We provide each customer with a dedicated professional with experience in performance and transportation

POLYDYN PERFORMANCE COATINGS

polydyn.com | 800-765-9396



POLYDYN PISTON SKIRT COATINGS

- We offer three different piston skirt coatings:
- RP – Composite polymer coating that holds oil
- PD14 Silver – Reduces friction in Alusil motors
- PD52G – Reduces galling in extreme pressure engines



POLYDYN PISTON TOP COATINGS

- We offer two different piston top coatings:
- Gold and titanium
- Protects piston structural integrity
- Enhances flame propagation



POLYDYN THERMAL CERAMIC COATINGS

- We offer seven different colors
- All rated up to 1,800 degrees
- Insulates for performance enhancement
- Protects against corrosion
- Recommended for exhaust systems, turbos, restoration, and hot rods



POLYDYN BEARING COATINGS

- We offer two different bearing coatings: DL & PD
- Both DL and PD have properties that attracts oil to the coated surface

RACELOGIC

vboxmotorsport.com | 248-994-9050

VBOX MOTORSPORT



VBOX VIDEO HD2

- System consists of dual 1080p cameras, allowing for a main view with embedded picture-in-picture
- HDMI socket allows for connection to live streaming device—ideal for engineers, driver coaches, sponsors, social media and TV broadcasting
- Customizable graphics overlaid in real-time
- GNSS data and up to 80 CAN channels recorded for analysis



VBOX HD LITE

- All-in-one video data-logging system for motorsport
- Records 1080p HD video with fully synchronized GNSS data
- Device starts and stops logging on its own, based on vehicle movement
- GNSS data and up to 8 CAN channels are recorded with the video
- Allows in-depth analysis via our Circuit Tools software



VBOX PIT LANE TIMER

- VBOX Pit Lane Timer takes the guesswork out of pit-stop periods during an endurance race
- Helps to avoid pit-stop penalties, minimizes time lost in the pits
- Prompts when to leave the pit box, and warns driver if they're likely to cross the line too early
- Fully configurable



VBOX TIRE TEMPERATURE MONITORING SYSTEM

- Enables teams to fine-tune the car and manage tires
- Each sensor measures up to 16 points across the tire surface with a temperature range of -4 to 1,724 degrees F
- Can be supplied as sensors and wiring loom for connection to VBOX Video HD2
- With VBOX Touch, live display can be seen by the driver in the most severe conditions

REDTIDE CANOPIES

redtidecanopies.com | 888-616-3611



SFI, FIA, CIK RACING SUITS

- Built-in arm restraints
- Custom designs
- Custom colors
- Pockets in the jackets on two-piece suits
- 360 radial arm gussets
- Gussets between the legs for better fit
- Euro back gussets in the one-piece suits
- Best embroidery

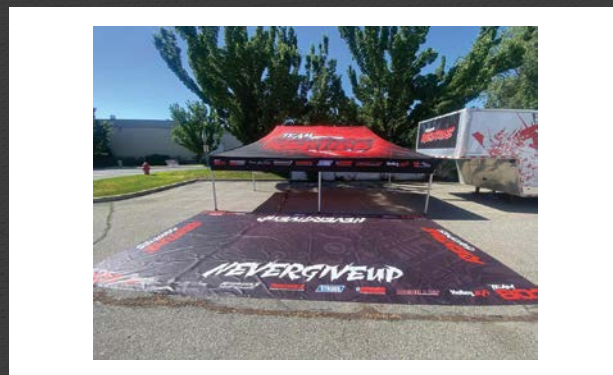

CUSTOM PIT MATS

- Custom printed pit mats
- Available for racers, car show events, etc.
- Can reduce grease inventory

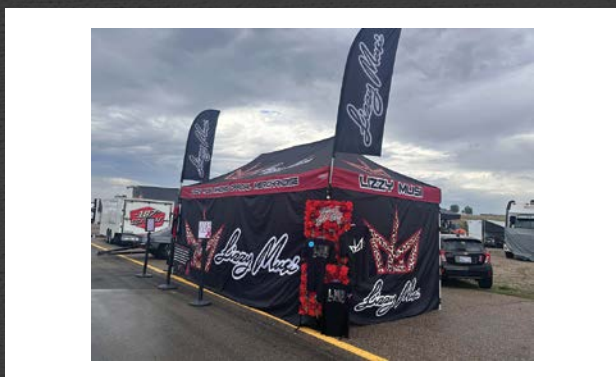

POP-UP TENT ENCLOSURE KITS

- Our tent kits are now even better, thanks to our new enclosure kits
- Walls are available with PVC windows
- Mesh or solid for extra privacy when working on race car
- Also protect merchandise at multi-day events



CREW APPAREL

- Custom designed and dye sublimated crew apparel for all forms of motorsports and business
- We produce everything, including full-color printed T-shirts, polo shirts, button-up shirts, pull-over hoodies, zip-up hoodies and long-sleeve track jackets

SCHAEFFER'S SPECIALIZED LUBRICANTS

schaefferoil.com | 800-325-9962



MICRON MOLY RACING OIL 10W-30 – NEW!

- Resists separating from alcohol-based fuels
- Extra zinc to protect flat-tappet cam engines and other components from wear
- Extra protection for when engines are operating at higher temperatures
- Keeps engines clean from harmful debris and buildup
- Reduces oil consumption



MICRON MOLY RACING OIL SAE 70 – NEW!

- Resists separating from alcohol-based fuels
- Extra zinc to protect flat tappet cam engines and other components from wear
- Extra protection for when engines are operating at higher temperatures
- Keeps engines clean from harmful debris and buildup
- Reduces oil consumption



PENETRO 90 PENETRATING OIL

- Excellent on heim joints, wheel studs and weight jack bolts that have become difficult to operate
- Prevents thread stripping, busts through rust
- Projects against corrosion, rust, and abrasive particles
- Frees stuck and rusted parts
- Doesn't affect seal materials or coatings



SUPREME GEAR LUBE 75W-90

- Reduces operating temperatures
- Enhanced thermal and oxidative stability and durability
- Excellent extreme pressure properties to protect against wear
- Enhanced gear, bearing, and seal cleanliness
- Compatibility with all types of seals

THE TUNING SCHOOL

thetuningschool.com | 727-264-8875



GM LS ENGINE COMPLETE TUNING COURSE

- Comprehensive printed and online LS-based learning set
- Processed-based tuning guides you through tuning your LS-powered vehicle
- Learn important concepts like how to tune a MAF, VE, Spark, Idle Control, Fueling and more
- Download the free mobile app for online learning from anywhere



ARTIFICIAL NEURAL NETWORK TRAINER FOR EFI TUNING

- Tunes the Artificial Neural Network found in 2015+ Dodge computers and late model GM vehicles
- Corrects fueling at idle, part, throttle, and wide-open throttle
- Other tools include Dodge and Ford Transmission Calculators
- Subscription based so you can use as much or as little as you like



DODGE HELLCAT COMPLETE TUNING COURSE

- Comprehensive printed and online Hellcat-based learning set
- Processed-based tuning guides you through tuning your Hellcat-powered vehicle
- Learn important concepts like how to tune a Speed Density, ANN, Spark, Idle Control, Fueling and more
- Download the free mobile app for online learning from anywhere



ATLAS BOOST CONTROLLER MAX FOR GM LT TRUCKS USING WHIPPLE SUPERCHARGERS

- Control your Whipple Supercharger's boost like never before
- Eliminate annoying transitional boost surge by controlling how the boost comes in and when
- Control the bypass valve with how fast and by how much the bypass valve opens and closes
- Improves drivability and control for positive displacement blowers

THERMO TEC AUTOMOTIVE

thermotec.com | 800-274-8437



ADHESIVE-BACKED HEAT BARRIER

- Shields components from radiant heat with its aluminized finish and woven silica material
- Handles up to 2000°F of radiant temperature and 300°F of continuous temperature
- Easy to apply on any surface or wrap around hoses and wires for a professional look



ALUMINIZED HEAT BARRIER

- Woven silica with a flexible aluminized finish
- Endures up to 2000°F radiant temperature and 1000°F fabric side
- Easy installation with rivets, backup washers, or adhesive
- Secure with Thermo-Tec's Snap Strap for manifolds or exhaust systems
- Customizable size for a perfect fit

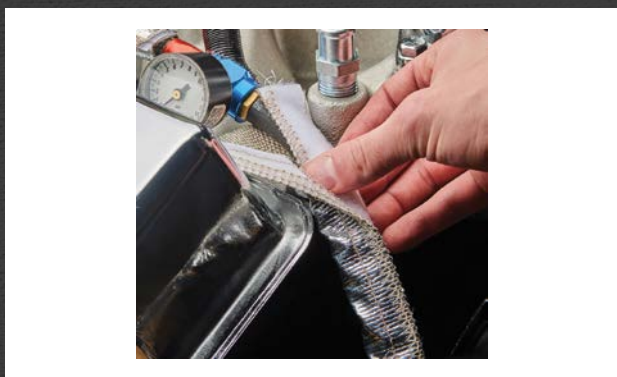

EXPRESS SLEEVE

- Ultimate solution for wire, hose, and cable protection
- With a hook-and-loop closure, it's easy to apply
- Combining high-temperature insulation with a reflective Mylar foil, it reflects over 90% of heat up to 2000°F
- Available in various sizes and lengths
- Made in the USA



EXHAUST WRAP

- Experience more horsepower and reduced under-hood temperatures
- Developed over 30 years ago, it maintains hotter exhaust gases for faster exit and increased scavenging
- Withstands up to 2000°F, asbestos-free, and won't over-insulate thanks to Thermal Conduction Technology (TCT) coating, ensuring optimal heat control

ULTIMATE AWNING

ultimateawning.com | 612-816-9644



TRAILER AWNINGS AND CANOPIES

- Patented connection and shelter system technology
- Protect what you can never get back—time



CAM-LOC QUICK CONNECTS

- Stop pulling cables to connect tubes
- Integrated billet aluminum connection technology



ULTI-LOC CONNECTORS

- Stop using quick aligns
- Stop inserting quick pins
- Stop flipping latches
- Integrated billet connection technology

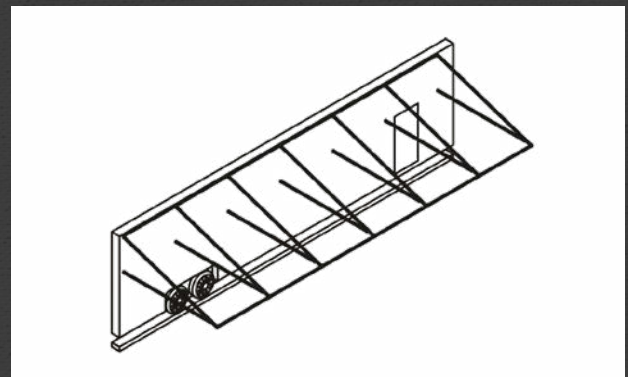

TRAILER AWNINGS AND CANOPIES

- “When your time is valuable”
- Stop pulling cables
- Stop inserting quick pins
- Stop wasting time
- Start using the Ultimate Awning

VP RACING FUELS

vpracingfuels.com | 210-635-7744



SPEED SAUCE PLUS

- 20/80 water-ethanol mix provides 4% more power than methanol-based injection fluids
- Delivers up to 15% more horsepower/torque than stock, with proper tuning
- Get added octane when needed thanks to the ethanol's > 115 octane rating
- 99% renewable, less corrosive, and less toxic than methanol



622 RACING BRAKE FLUID

- Full synthetic formula features a dry boiling point temperature of 622°F
- Resists vapor lock & fade for a better pedal feel
- Gives you the confidence to stop on a dime
- Designed for racing but provides the same trusted performance for street and powersports vehicles



POWERSPORTS 4T & 2T ENGINE OILS

- Advanced formulation provides ultimate lubrication protection, excellent temperature resistance, and wear protection
- Ensures superior performance and reliability in all riding conditions
- Designed for street & off-road bikes and ATVs/UTVs
- 2T oils are available in full and semi-synthetic blends
- 4T oils available in full synthetic, semi-synthetic, and conventional blends



MGP R REG RACE FUEL

- An upgraded moto fuel, offering better performance and detonation protection than VP MGP
- Certified by FIM's official lab. Maximizes all parameters under the FIM fuel rule
- Spec fuel for Moto America starting in 2024

WIELAND PERFORMANCE PRODUCTS

wieland-metalservices.com | 708-385-7000

wieland

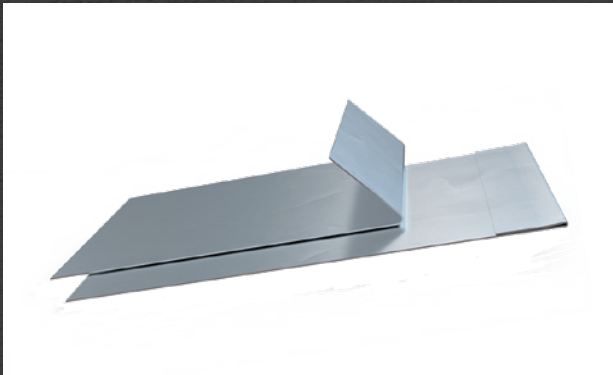

ALUMINUM SHEETS FOR CAR BODIES AND SPOILERS

- Wieland aluminum sheets are bendable, long lasting, and rust resistant
- Makes them the perfect fit for your racing needs
- Popular racing colors like Ultra White, Black Gloss, Black Matte, Red and Chevron Blue
- Stocked in gauges .040- and .050-inch

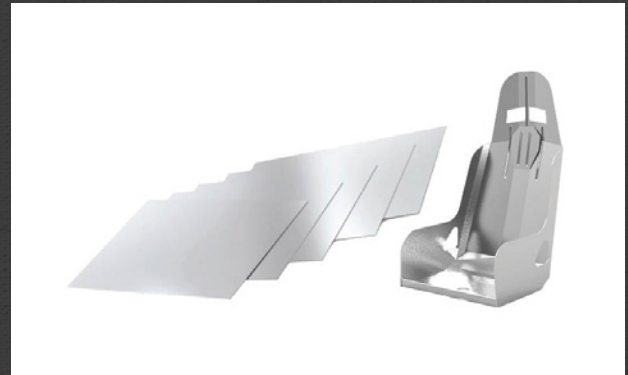

ALUMINUM SHEETS AND COIL FOR RACE CAR SEATS

- Wieland is going inside the vehicle
- After decades of supplying premium car body aluminum sheet, we are proud to stock .080- and .125-inch gauge 5052 aluminum specifically for race car seating

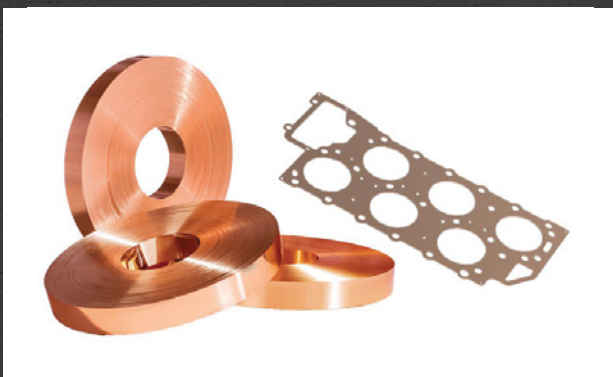

COPPER SHEETS AND COIL FOR GASKETS

- Wieland is under the hood
- We are stocking 110 copper alloy in multiple gauges for header gasket production
- This new and exciting addition expands our performance products line

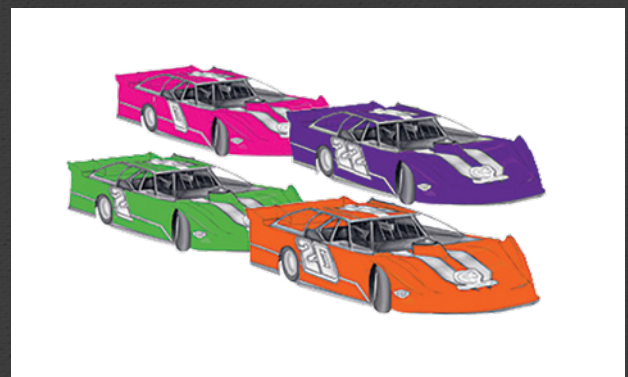

ALUMINUM SHEET COLOR OPTIONS

- Announcing the Wieland Exotic Series
- Stop by booth 3121 at the PRI Show
- Get acquainted with Bright Orange, Extreme Green, Power Purple, Electric Pink, and other exciting new colors
- Realize your custom look and stand out on the track

WORLDWIDE EXPRESS

wwex.com/pri | 214-720-2400



LEADING CARRIER PORTFOLIO

- Comprehensive small package and freight services from the nation's largest UPS Authorized Reseller
- Portfolio of 75+ leading Less-than-Truckload (LTL) and 85,000 Full Truckload carriers, including top names you know such as Estes, XPO, Saia, R+L Carriers, Old Dominion, Forward Air, and more



TAILORED SHIPPING TECHNOLOGY

- Integration-ready, self-service transportation management technology that lets you quote, compare, ship, track and report from either the intuitive SpeedShip interface or your own ERP system
- Ability to plug in to leading e-commerce platforms like Adobe Commerce/Magento, WooCommerce, and Shopify

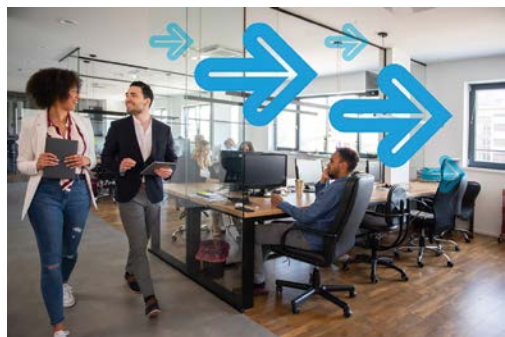

UNMATCHED CUSTOMER SERVICE

- 500+ support professionals – live, local, and specially trained to support real-time needs and proactively anticipate roadblocks
- Access to flexible invoicing options, market-leading insurance coverage, and one-to-one shipment consultation



TRUSTED TO DELIVER

- Service you can rely on by the Official Logistics Partner of NASCAR, Richmond Raceway, Trackhouse Racing, and Niece Motorsports
- Successfully delivered critical infrastructure for the heart-pounding action of the Busch Light Clash at The Coliseum and the Chicago Street Race Weekend



**BULLY DOG
GT DIESEL PERFORMANCE
TUNER & MONITOR**

- Custom fit for improved sound and comfort
- Preloaded tunes
- Tire size adjustment
- Axle ratio adjustment
- Speed limiter
- Read and clear DTCS
- Set warning levels

Contact: 407-774-2447
bullydog.com



**CHEYENNE REED RACING
APEX SFI RACE SUIT**

- SFI 3.2A/5 Certified
- Double layer construction
- Tailor fitted and GUARANTEED to fit
- Imported Chamatex Nomex from France
- Any custom design
- Unlimited embroidery/logo placement
- One- or two-piece construction
- ComfortStretch seams and movement panels increase breathability and comfort

Contact: 510-990-0099
acceloracewear.com



**CHICANE RACING
CHICANE SPEEDSTER**

- Designed for HPDE and performance driving
- Low-cut version of the company's GT3 race boot
- Michelin rubber soles
- Pilot Sport tread design
- Non-marking and anti-static
- Fuel and oil resistant
- For men and women

Contact: 406-570-5886
chicaneracing.com



LET GIANT FINISHING
"THE METALS FINISHING
EXPERTS" HELP YOU CREATE/IMPROVE
YOUR FINISHING PROCESS. WE RUN
SAMPLE PARTS
FREE OF CHARGE. LET
US HELP CREATE A RECIPE
WITH THE RIGHT MACHINE,
MEDIA, & CHEMISTRY TO
FINISH YOUR PARTS
CONSISTENTLY EACH AND
EVERY TIME. CALL US TODAY.

708-343-6900

www.giantfinishing.com

GIANT
FINISHING, INC.



**COMPUTECH SYSTEMS
RACEAIR CLOUD RACING
WEATHER STATION**

- Top-of-the-line racing weather station
- Quick and easy set-up with all parts included
- RaceBase drag racing ET prediction and logbook software
- Ultimate weather station and software for bracket racers
- Best customer service and support in the industry

Contact: 301-884-5712
computech.com



**DAVIS TECHNOLOGIES
TRACTION CONTROL**

- Traction control for all types of racing
- Extremely accurate and fast
- Self learning
- Patented
- 25 years specializing in traction control

Contact: 828-645-1505
moretraction.com



**DAYTON LAMINA CORPORATION
DAY LUBE HIGH
PERFORMANCE GREASE**

- High temperature
- Low drag
- Long lasting

Contact: 937-384-3626
daytonlamina.com



NEW GODZILLA CAM LINE
ISKENDERIAN CAMS
HUNDREDS OF NEW CAM GRINDS
FOR LS, LTI APPLICATIONS

SHOP ONLINE 24/7 - TRY OUR EASY MAKE AND MODEL SEARCH!
WWW.ISKYCAMS.COM 310.217.9232

 /ISKYRACINGCAMS
 /ISKYRACINGCAMS



**DIGITAL RACING CARDS LLC
RACE FACE DIGITAL
COLLECTABLE CARDS**

- The ultimate entertainment platform
- Buy, sell, and trade MP4 collectible cards
- Drivers - Promote your brand
- Fans - Play Capture The Flag and win \$25k
- Join the Savings HUB Community
- New digital hero cards

Contact: 727-247-5597
racefacedigital.com



**DRIVELINE STUDIOS
DRIVELINE STUDIOS BRAND
VIDEO PACKAGE**

- Driveline Studios drives growth by creating engaging content for the world's best brands
- This one-day package is the perfect blend of motion and stills for your brand
- One-day immersive photo & video shoot
- One long-form brand video
- Three short-form social media clips
- 25 high-quality digital photos

Contact: 813-625-4495
drivelinestudios.com



**EQ SYSTEMS
HYDRAULIC BUMPER PULL TJ**

- Available for bumper pull and towable trailers
- Uses the same three-bolt triangle hole pattern as manual or electric jacks for easy installation
- 16-inch stroke cylinder
- 6,000 lbs. lifting capacity
- Commercial single function pump with manual override screw drive
- Simple rocker style switch control

Contact: 800-846-9659
eqsystems.us

**DON'T GIVE IT A
SECOND THOUGHT**



SERIOUS OIL PUMPS



The unique Peterson R4 rotor design develops solid oil pressure, even at high temperature conditions and it pulls serious vacuum too. A standard rear drive setup allows for direct mounting of all popular drive accessories. Fire it up, forget about it and know that R4 will help ensure your engine never misses a beat.



1.800.926.7867
petersonfluidsys.com



TANKS PRIMERS ACCESSORIES



By  **Specialty Products Company**

©2023 Niwot Corp. dba Specialty Products Co.®

**SEE US AT PRI
BOOTH #3413**





**G-FORCE RACING GEAR
G-PRO CREW SHOES**

- Perfect choice for pit crew or track safety personnel
- Built to be extremely tough and to endure
- Leather cowhide and microfiber upper
- Slip-resistant sole
- SFI 3.3/5 certified
- Available in sizes 8 to 16

Contact: 770-998-8855
gforce.com



**HMS MOTORSPORT
SCHUBERTH SK1 CARBON**

- The SK1 Carbon is Schubert's first SNELL FIA CMR 2016 karting helmet
- Derived from years of Formula 1 experience and built with the same technologies found in automotive models
- Achieve a custom helmet using adjustable pads, various spoilers, and ventilation scoops
- Available in sizes 54-59 cm
- Starting at \$1,200.00

Contact: 978-774-1615
hmsmotorsport.com



**HOT SHOE RACEWEAR
PRO ELITE DRIVER'S SUIT**

- Custom two-layer construction
- Made from lightweight Nomex
- Features inner-liner suit
- Includes unlimited embroidery, radio pocket, boot cuff and 360-degree arms and action back panel
- SFI 3.2A/5 certified

Contact: 717-701-1599
hotshoeracewear.com

SERDI

The most reliable engine rebuilding equipment



4.5

3.5

PROFILE



SG 330

STANDARD AND CUSTOM BITS

SPARE PARTS AND EQUIPMENT

PILOTS



**See us at
PRI 2023**

Machinery row
Booth 5201



SPT 1600

SERDI CORPORATION
customerservice@serdi-usa.com - +1(800) 447-3790 - MOORESVILLE NC 28117



**HOT SHOT'S SECRET
ADRENALINE ASSEMBLY
LUBRICANT**

- Formulated to blend with 100% of break-in oils, while also providing supreme protection and swift solubility
- Offers unrivaled cling and tackiness to any surface it is applied to, such as camshaft lobes, bearing surfaces, fasteners, and studs
- Provides lasting protection for stored applications and ongoing projects

Contact: 614-354-8833
hotshotsecret.com



**HP TUNERS
CORE BY HP TUNERS**

- CORE ECU and VCM Live software
- HP Tuners' debut standalone engine management solution delivering superior engine control
- CORE ECU currently supports LS applications with a 24x crank and 1x cam trigger along with 58x crank and 4x cam triggers
- Available for purchase in early 2024
- For off-road use only

Contact: 224-900-0269
hptuners.com



**HUSHMAT & ZYCOAT
ZYBAR HIGH TEMPERATURE,
HEAT DISSIPATION COATING**

- A spray-on thermal dissipation coating for headers, manifolds, exhaust, and turbos
- ZyBar heat dissipation technology, proven in third-party testing, improves scavenging performance to increase horsepower and boost torque
- Ultra smooth, pure luster finish is non-corrosive
- Reduces radiant heat by 90% and underhood temperatures by 40%

Contact: 913-599-2600
zycoat.com

**UNRIVALED
PERFORMANCE
SPAL ELECTRIC COOLING FANS**



Crafted by professionals for professionals, SPAL electric cooling fans provide extreme reliability, superior durability and unrivaled performance under the most challenging conditions that is second to none. Stop by our booth (#1435) at the 2023 PRI Show to see the latest in cooling technology from SPAL!



SPAL AUTOMOTIVE USA
PHONE: (800) 345-0327
EMAIL: INFO@SPALUSA.COM
WEB: WWW.SPALUSA.COM



INDY RACE PARTS
ONE STOP SHOP-SPRINT CARS

- All your sprint car part needs
- 10 minutes from the Indiana Convention Center

Contact: 317-244-9437
indyraceparts.com



INEARZ SPORT
UH-1 CUSTOM FIT UNDER HELMET EARPHONES

- Custom fit for improved sound and comfort
- Low profile for under helmet use
- Available in soft silicone, durable acrylic, or our industry exclusive hybrid of silicone and acrylic called FusionSoft
- Built using the latest digital manufacturing technology for improved fit
- Available in mono or stereo configurations

Contact: 407-339-2422
inearzsport.com



INTECH TRAILERS
INTECH LITE SERIES TRAILERS

- A value-priced, all-aluminum car hauler with the same quality, fit, finish, and attention to detail that is found in every inTech Trailer
- Lite Series trailers have much shorter lead times than our custom trailers, and are available in several lengths and configurations
- Tag (Bumper Pull): 20 foot, 24 foot and 28 foot
- Gooseneck: 40 foot
- Stacker: 24 foot, 28 foot and 32 foot

Contact: 574-773-9536
intech.com

PERFORMANCE PRODUCTS FOR DIESEL TRACTOR & PICK-UP TRUCK PULLING MACHINES

- *TURBOCHARGERS
- *FUEL SYSTEMS
- *COMPLETE ENGINES
- *ENGINE COMPONENTS
- *CLUTCHES & FLYWHEELS
- *TRANSMISSION GEARS

HYPERMAX DIESEL FUEL INJECTION

- *In-Line Mechanical Injection Pumps
- *Common Rail Injection Systems for
- *6.7L Ford & 7.3L Navistar Engines

FORD DIESEL PERFORMANCE

- *PICK-UPS, VANS, EXCURSIONS
- *ENGINE COMPONENTS
- *EXHAUST SYSTEMS
- *INJECTORS
- *INTERCOOLERS
- *TURBOCHARGERS
- *ELECTRONICS

"BONE TWISTER"

MANIFOLDS **CYLINDER SEALING**

TURBO SYSTEMS **"BULLET PROOF" 4 Bolt Main IH Block** **"HIGH FLOW" CYLINDER HEAD shown with 4 bolt main IH block** **INJECTION SYSTEMS**

7.3L IN-LINE FUEL INJECTION PUMP ENGINE Common Rail System also available **VALVE TRAIN COMPONENTS** **ENGINE COMPONENTS**

DIESEL POWER **Hypermax ENGINEERING**

HYPERMAX DIESEL DRAGSTER **HYPERMAX/IH DT 466 TRIPLE TURBOCHARGER** 3,600 LB. NHRA TOP DIESEL DRAGSTER 216.27 MPH/6.69 E.T.

255 EAST ROUTE 72 GILBERTS, ILLINOIS 60136
847-428-5655 + GOHYPERMAX.COM

PROFESSIONAL STRENGTH CORROSION INHIBITORS AND LUBRICANTS

SUSPENSION ■ ENGINE ■ ELECTRONICS KILLS CORROSION ON CONTACT

Stop by for a **FREE SAMPLE**

LEAR CHEMICAL RESEARCH CORPORATION
www.acf-50.com 1.800.256.2548

PRI BOOTH# 1612



**ISSPRO
EV3 GAUGES**

- Bluetooth built into circuit board
- Free app for gauge programming
- Multi-colored LEDs for customizable back lighting and pointer colors
- Sold as a kit
- Made in the USA

Contact: 503-528-3400
isspro.com



**JAZ PRODUCTS
BILLET THREADED-CAP
ASSEMBLIES**

- Billet aluminum threaded cap (non-vented) with matching bezel
- Available in red anodized finish for 6-bolt
- Also blue anodizing for 12-bolt
- Complete with all hardware and gasket
- Approved by most racing sanctioning bodies

Contact: 805-525-8800
jazproducts.com



**JOIE OF SEATING
LW CUSTOM**

- Only full custom, round, aluminum seat on the market
- Fits great in asphalt late models, modifieds, road racing applications, and more
- Fully custom fitted to the driver's measurements
- SFI 39.2 rated

Contact: 704-795-7474
thejoieofseating.com

**DIAMOND
CLAW®**
SURFACE LOCK



We
Protect
Precision



Diamond Claw® Surface Locks Eliminate
Component Damaging Surface Welding
Available for all types of crankshafts & drive-lines



www.shaftech.com • 419.423.1000



**CONSTANTLY MORE THAN
JUST BATTERIES**

BOOTH #3621



XSPOWERBATTERIES.COM



KD KANOPY THE PREMIER PURVEYOR OF POP-UPS

- KD Kanopy invented the scissor-action, pop-up canopy 40 years ago and has since been an innovator in the industry
- The patented Starshade revolutionized the look of portable event tents, providing an alternative to the square, four-post canopy tent
- Your brand becomes the star of the show when housed within this striking design

Contact: 303-650-1436
kdkanopy.com



MAXX-D TRAILERS MAXX-D A6X 10K DROP-N-LOAD AIRBAG CAR HAULER

- 9,990 lbs. GVWR, 20' or 24' deck length
- Airbag suspension for a smooth ride and easy loading
- No more ramps - steel floor deck raises and drops to the ground with the push of a button
- Seven-degree loading angle
- Full-length running boards with a split-tail in the rear

Contact: 352-629-1562
maxxtrailers.com



MEL HAMBELTON RACING THE PIT MAT

- Black foam rubber mat is grease and oil resistant
- Non-flammable
- Provides comfort when working in the pit or on shop floor
- Slightly smaller size means no oversize shipping fees
- Dimensions: 45" long, 28" wide, 1 1/4" thick

Contact: 316-462-1430
racemh.com

UNBEATABLE PERFORMANCE



- the all-new setrab **super** series remote oil coolers.
- smaller size, larger performance
- absolutely none better.

Setrab

see more of what's cool at www.susa.cool

susa
SetrabUSA.com

KEEP UP WITH PRI



PRISHOW.COM/SOCIAL

PRI
PERFORMANCE RACING INDUSTRY



**MOTEC SYSTEMS USA
M1 ECU**

- Latest generation high-performance processor
- Large logging memory, fast ethernet downloads
- Compact and lightweight in robust magnesium enclosures
- Supports direct injection and port injection applications
- Suitable for ICE, hybrid or EV platforms with one controller

Contact: 704-799-3800
motec.com



**NITRO MANUFACTURING
CUSTOM PRODUCTS**

- Prototyping
- CAD modeling & design
- Waterjet cutting
- CNC machining & router machining
- Welding
- Custom fabrication
- Shearing & breaking
- Surface plates
- Race products, karting products, and much more

Contact: 704-663-3155
nitromfg.com



**PENNGRADE1
BRAD PENN HIGH
PERFORMANCE ENGINE
ASSEMBLY LUBRICANT**

- Green in color
- Premium high-viscosity lubricant specifically designed to offer additional protection during the engine assembly process
- Its Pennsylvania Grade base oil provides higher load carrying ability and excellent surface film protection to prevent wear to components in highly stressed assembly applications

Contact: 317-923-5321
penngrade1.com

**Stainless Headers
MFG. INC.**
PERFORMANCE ENGINEERED COMPONENTS
1-800-290-3920

MANDREL BENDS **MERGE COLLECTORS**
HEADER BUILD KITS **OVAL EXHAUST**

TURBO HEADERS
CUSTOM DOWNPIPES

PROUDLY MADE IN USA

SEE US AT PRI BOOTH #3107
WWW.STAINLESSHEADERS.COM

KINSLER

We did the Lucas metering for the Can-Am: 60's thru 70's; still do. Any injection: Road race, Sprint cars, Boats, Indy 500, NASCAR Cup, Drags, Motor-cycles, Bonneville, Pullers, Street, etc. EFI, Constant Flow, Lucas Mechanical

2023
410 World of Outlaws Sprint Car, Kyle Larson
WoO Knoxville Nationals Champion

2023
360 ASCS Sprint Car, Brian Brown
ASCs Knoxville Champion

2023
Race Saver Sprint Car, Tyler Druke
Quickest Lap Time at Nationals

**Ultra Monster Mesh™
Pump Pre-Filter**

BEAST

RAPTOR

RS 305

TOUGH PUMP

K-140 High Speed Bypass Valve

One-piece gear-shaft, extreme materials, coatings, tolerances, and rock solid housing, give superb durability. Pressure Balance Plate System (Pat. Pend.) gives rock steady flow throughout the RPM range.

Most Precise & Repeatable Opening & Closing Pressure

Zero Failures in 10 Years Since 1st Sale

(248)362-1145 Kinsler.com sales@kinsler.com



POWER AUTOMEDIA NINE EXPERTLY CURATED AUTOMOTIVE MAGAZINES

- Chevy Hardcore - Unadulterated Chevrolet Performance
- Diesel Army - Turn up the torque
- Dragzine - Hardcore drag racing - 24 hours a day
- EngineLabs - The science of horsepower
- Ford Muscle - Capturing the blue oval spirit
- LSX Magazine - LS swap the world
- Off Road Xtreme - Share the adventure
- Street Muscle Magazine - Putting the 'street' back in 'street cars'
- Electrified - The forefront of EV technology

Contact: 951-677-2626
powerautomedia.com



PYROTECT SAFETY GEAR PYROTECT SA2020 PRO AIR FLOW VORTEX MID-FORCED AIR CARBON FIBER FULL FACE HELMET

- New SA2020 redesigned Tri-Weave composite helmets
- Six-pad interior system for better heat transfer
- Vacuumed bagged and autoclave cured
- Stainless steel hardware and Kevlar chinstrap
- New head liner air channel design
- Compatible with Racing Optics or Ultra Shield tear-offs
- Sizes 2XS to 3XL
- Weighs 3.4 to 3.6 pounds

Contact: 800-669-2355
pyroprotect.com



RACETECH MANUFACTURING RT4200 RACE SEAT

- Improvements in the areas of comfort and safety
- Closer in feel through the rib and torso area
- Signature features such as back-mounting, pronounced thigh support, a molded base cushion, parallel sides, and flush bosses for ease of mounting are all present
- Lightweight, resin-infused shells
- FIA 8855-1999 approval
- Three sizes

Contact: 704-450-4507
racetech-usa.com

WOOLF AIRCRAFT

Specializing in Tube Fabrication:
Bending and Welding Since 1942



PRISHOW
BOOTH 3211

734-721-5330 WOOLF AIRCRAFT.COM

ALTRONICS

PERFORMANCE ELECTRONICS

The Original
PerformAIRE
WEATHER STATIONS



POWERLITE
Lithium Batteries



POWERQUEST
Touch Screen PDM System



Programmable
Switch Panel
Power
Distribution



Stop by Booth #1338 to see all our products!

Tech Support 7 days a week! AltronicsInc.com 1-847-923-0002 Mention AD# PR123 for discount!



RACING ELECTRONICS
PREMIUM PRO-LEVEL CUSTOM EAR MOLDS

- Introducing our new Premium Pro-Level Custom Ear Molds
- 'Comfort fit' custom molding process
- 3-D digital scanning/archival process for repeatability
- 'No tangle' abrasion resistant cord
- Bottom exit cord placement
- Enhanced audio clarity
- Industry standard stereo connector
- Deluxe zippered storage case
- Made in Concord, NC, USA
- Located at Booth 4721 at PRI

Contact: 800-272-7111
racingelectronics.com



RETRO-FIT USA
A/C FITTINGS AND HOSES

- Made in the USA
- Aftermarket A/C fitting and hose kits
- Automotive (hot rod), truck (heavy/light duty), RV, bus, agricultural, and construction vehicle applications
- Place your order directly on our website
- Products typically ship within 48 to 72 hours

Contact: 810-625-2889
retro-fitusa.com

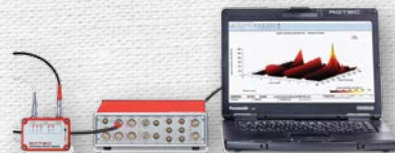

ROTEC
ROTEC RASDELTA

- Measurement system for investigation/analyses of drive trains, gearboxes, turbines, and roller elements
- Precisely analyze causes of acoustic problems and damaging (torsional) vibration
- Provides significant product development results for spring, damping, and component design

Contact: 248-685-8148
rotec-munich.de/en/

SCHUMANN'S PERFORMANCE WET SUMP OIL PUMPS

DRAG
CIRCLE
TRUCK RACING } **ALL CLASSES**

NEWEST PATENTED DESIGNS!

- "140 PRO MAX", Low Load Bypass
- "PADDLE WHEEL", Gear to Gear SBC, BBC, OLDS, Pontiac

ENERGY RECOVERY

- 30 to 40% Less Energy to Operate
- Turbo Charged Intake Cycle
- No Atmospheric Pressure
- Vacuum Pan Friendly
- "ANNULAR FLOW" LS Engine Technology

**"WET SUMP OIL PUMPS"
WITH DRY SUMP ATTITUDE**



Call Verne at
1-563-381-2416
PO Box 128, Blue Grass, IA 52726
www.schumannssalesandservice.com
sss1554@aol.com

ONE STOP FOR ALL YOUR PERFORMANCE NEEDS

Visit us at
PRI 2023
Booth # 2137



Over

25 YEARS

of manufacturing excellence



American made products —
Supplying the racing industry
for over two decades!

*TRACK TESTED
RACER APPROVED!*

prpracingproducts.com



SCT X4 7015PG-B

- Preloaded tunes, Custom tuning
- Fuel octane AutoStart-stop, Rev limiter
- Tire size adjustment, Axle ratio adjustment
- Speed limiter, Read and clear DTC
- TPMS, Crank relearn
- Kam reset

Contact: 407-774-2447
sctflash.com



SHOCKER HITCH SHOCKER HD 20K MAX BLACK AIR RECEIVER HITCH

- 10+ ball mounts to choose from: combo, drop, raised, pintle, sway bar tab options and more
- Built-in HD airbag: absorbs road shock
- Eight adjustment holes: up to 2 inches of rise, 8 1/2 inches of drop
- 20k pounds GTW: available for 2-inch, 2 1/2-inch & 3-inch receiver tubes
- Smoother, safer towing

Contact: 701-707-2666
shockerhitch.com



SIMGEAR SIMGEAR MOTION4

- Turnkey 3DOF motion racing simulator
- Delivery and white-glove installation available
- New design for 2024

Contact: 630-283-2090
simgear.com

GANDRUD

PERFORMANCE PARTS



CHEVROLET PERFORMANCE
VEHICLES / PARTS / RACING



www.gmperformancemotor.com

Visit Us at PRI Booth #4406



PRECISION SHIMS WIN THE RACE

BOKER'S, INC.

Get a Fast Quote  SCAN OR EMAIL
SALES@BOKERS.COM

PRECISION SHIMS, WASHERS & STAMPINGS—SINCE 1919
(800)-WASHERS bokers.com



**SOUTHERN ADRENALINE
CUSTOM FIT RACE
RECEIVERS**

- We take an impression of your ears and make you custom fit Raceceiver Monitors
- Perfect fit every time for better comfort and durability
- Standard 3.5-mm mono jack plug and 18-inch cord

Contact: 817-371-2350
southernadrenaline.net

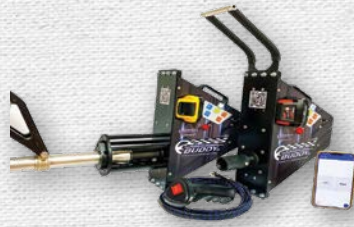

**STEERING BUDDY
STEERING BUDDY**

- Steering Buddy is like having an extra crew member
- Effortlessly steer your car around the pits, in and out of the trailer and through inspection
- Remove your steering wheel and slide on your Steering Buddy
- Operated by hand controller or Apple/Android app
- Applications for dirt, asphalt, drag, and northeast modified

Contact: 256-624-0645
steeringbuddy.com



**STROUD SAFETY
INERTIA FRONTAL HEAD
RESTRAINT**

- Controls the head's entire movement forward in an impact
- Prevents a sudden stop in an impact
- Reduces both linear and angular acceleration
- Reduces both concussion-causing forces and upper neck tension

Contact: 405-632-2022
stroudsafety.com



**TECHNOCRAFT CABINETS
WHEEL WELL CABINET**

- Convenient, out-of-the-way organization for oil, chemicals and consumables
- The best storage value available for your trailer

Contact: 931-379-5500
trailer cabinets.com



FIND OUT WHY THE
MOST KNOWLEDGEABLE
ENGINE BUILDERS AND
RACERS HAVE MADE THE
SWITCH TO CAM MOTION
CAMSHAFTS

ADVANCED CAMSHAFT
DESIGN FOR DOMESTIC
V8 ENGINES:
LS, LT, GEN 3 HEMI
SBC, BBC, SBF



BOOTH #2307

CAMMOTION.COM



TIMPTE TIMPTE MOTORSPORTS

- All aluminum trailers
- No structural welds
- EZ Load powered drop deck

Contact: 402-954-8001
timppte.com



TRAILER ALARMS PTS-2 BASIC TRAILER SECURITY SYSTEM

- Security in an instant
- Sounds 120dB siren
- Flashes running lights
- Locks electric brakes
- Possible insurance discount

Contact: 877-604-7381
trailer-alarms.com



TRENSOR 3FP PERFORMANCE RACING PRESSURE SENSORS

- Ultra-premium design for harsh automotive environment
- Widely used in racing, off-road, and specialty markets
- Compatible with most aftermarket ECUs
- Works with most aftermarket data acquisition systems

Contact: 949-379-6730
trensor.com



TW METALS METALS

- A worldwide distributor of standard & custom metal tube, pipe, rod, bar, extrusions, sheet, and plate products
- Types of metal include 4130, aluminum, stainless steel, nickel, and titanium
- Markets served include aerospace, nuclear, marine/shipbuilding, motorsports, chemical processing, pharmaceutical/medical, food service/restaurant, & government/military
- Materials meet many ASME, ASTM, AMS, Mil-T, and customer specific specifications

Contact: 800-545-5000
twmetals.com



ULTRA SHIELD RACE PRODUCTS PLATINUM PRO LATE MODEL SEAT

- Constructed from .100 & .125 Grade 5052 Aluminum
- One-piece design with tapered butt
- 25° shoulders
- 20" long bottom for more support during longer races
- Upgraded black Nomex style head surround with high density removable padding and cut outs for easier HANS/Hybrid access

Contact: 903-894-3550
ultrashieldrace.com



VANSON LEATHERS VANSON CAR RACE SUITS

- One-piece (double zipper) and two-piece suits, SFI-1 and SFI-5
- Made with CarbonX material and designed to be neutral in the car
- Can be customized in sizing for a guaranteed fit
- Embellish your suit with graphics made from embroidery or leather
- Made 100% in the USA

Contact: 508-678-2000
vansonleathers.com



WILWOOD ENGINEERING XR RACING BRAKE FLUID

- The most advanced race-proven fluid available in motorsports globally
- 645° F dry boiling point is one of the highest of any brake fluid
- Formulated to deliver the most consistent and reliable pedal feel in the most adverse racing conditions
- For off-highway use only—not DOT approved

Contact: 805-388-1188
wilwood.com



WORKS INNOVATION MERU SAFETY ASCENT CARBON

- The first SFI 38.1 FHR with a built-in hydraulic shock absorber
- Patented IDS system is designed to slow the head during impact and reduce concussion causing forces
- The IDS shock features speed sensitive valving to maintain driver comfort and work for a wide array of impacts

Contact: 405-504-8797
meru-safety.com

grandbending.com

WE'RE OBSESSED WITH BENDS TOO



With over 20 years of experience in fabricating custom and high-performance exhaust systems for race cars, vehicle restylings, and restorations—you might say we're obsessed. All Grand Bending products are available in aluminized carbon steel and stainless steel thin-wall tubing and utilize short-radius tube bends measuring 1½–5 inches.



Got a new project coming up? Call 770-426-0734 or email us at sales@grandbending.com today.

CRAFTED IN THE USA



1092 W Atlanta St, SE, Bldg. 1200 Marietta, GA 30060

CARBURETOR ADAPTERS AND SPACERS **OIL AND FUEL FILTERS**

PERFORMANCE OIL PANS AND ACCESSORIES **OIL FILTER ADAPTERS AND MOUNTS**

ACCUSUMP™ OIL ACCUMULATOR **COOLANT ACCESSORIES**

VALVE COVERS **ALUMINUM TANKS**

203-481-9460

WWW.CANTONRACINGPRODUCTS.COM

CHECK OUT WHAT'S NEW FROM PYROTECT FOR 2023!

PYROTECT
www.pyrotect.com

NEW PYROCELL ELITE Standard Fuel Cells and Bladders from 5 to 60 Gallon. FIA-FT3 Approved.



NEW CUSTOM FUEL CELLS Specializing in Custom Fuel Cells any size or shape. FIA-FT3 & FT3.5 Approved.



NEW PRO SPORT SA2020 TFA HELMET Available in White, Flat Black, Gloss Black, & Carbon



NEW PRO SPORT SA2020 SFA HELMET Available in White, Flat Black, Gloss Black, & Carbon



NEW FIA CAMLOCK HARNESS with Lt. Weight Adjusters. Available in 6 Point, Black, Red, Blue and Silver.



THE PYRO CELL FUELING TOWER from PYROTECT Available in 35, 50, 75, 100 Gallon.



NEW SINGLE & DUAL MOUNT PLATES Available for Automotive or Weldon High Performance Pumps.



FIA ANKLE TOP RACING SHOES Available in Red, Black and White.

Now Order Online at www.pyrotect.com or call us toll free at 800-669-2355.

FUEL CELLS • HELMETS • FIRESUITS • SEATBELTS • GLOVES • SHOES

ZAMP

Z-TECH SERIES 8A HEAD & NECK RESTRAINT

- A lightweight restraint available in small, medium, and large sizes
- Stainless steel helmet clips
- Kevlar webbing
- Shorter arms
- No rigid materials on the spine
- SFI 38.1 certified

Contact: 208-506-3030

zamp-racing.com

UNITED

RACE PARTS®

PIT EQUIPMENT HEADQUARTERS

FEATURED PRODUCTS

DP6000-LH SPLINE



Paoli's patented spline drive has now been applied to the DP6000. Increased socket engagement offers more torque and smoother operation.

SEAMLESS GARAGE WALLING



Seamless aluminum garage & hospitality walling. Completely customizable to your layout needs with graphics, LED's, logo lights, TV's, storage, doorways and more.

200L FUEL BOWSER



Accurately pump fuel in and out of the car or fuel rig. The built in load cells integrate with the Greaves Fuel Timer Management Software.

North America's exclusive distributor
and service center for:

paoli
PIT STOP

GREAVES
ENGINEERING

quanton
A ONE OF EXCELLENCE



+1.704.500.2000 // [f](https://www.facebook.com) [i](https://www.instagram.com) [y](https://www.youtube.com) [in](https://www.linkedin.com)
UnitedRaceParts.com

VISIT US AT **PRI** BOOTH #915

ACT

ADVANCED CLUTCH TECHNOLOGY®

30 YEARS

— SINCE 1994 —

POWER HELD HERE.



SEE US AT BOOTH # 1701



206 EAST AVE K4, LANCASTER CA 93535
ADVANCEDCLUTCH.COM | 661-940-7555



SECTION

4

MACHINERY, TOOLS & EQUIPMENT

Discover the latest tools, machinery, and equipment that will save your shop time and resources as these new models debut innovative features to improve the building process.

PRI SHOW

JOIN US LIVE

the real **SKINNY**
With Rico & Ken



THE SKINNY WITH RICO & KEN
LIVE FROM THE MAVTV PRI SHOW BOOTH #4501

THURSDAY
10 AM • 11 AM • 1 PM

FRIDAY
10 AM

MAVTV[®]

YOUR GLOBAL MOTORSPORTS HOME

AT&T U-verse

DIRECTV

fios[✓] by verizon

YouTubeTV

Spectrum

hulu
+ LIVE TV

fubo^{TV}

WWW.MAVTV.COM



COMEC

comecus.com | 800-887-6076



ACF200 CNC

- CNC boring mill for boring, surfacing, and other operations
- Simple conversational control
- Dual panel touchscreen operator control
- Ballscrew drives and linear slideways
- Three-axis brushless servomotors



RP1400CNC

- CNC head and block resurfacing machine
- Simple conversational control
- Touchscreen operator control
- Ballscrew drives and linear slideways
- 16-inch CBN/PCD milling head



LEV 300

- Automatic vertical stroke cylinder honing machine
- True linear stroke with ballscrew drive
- Simple CNC touchscreen control
- Independent variable stroke and spindle for user defined crosshatch angle
- Bi-directional hone head feed
- Uses Sunnen AN style stones, 2.5–5.5-inch diameter



RV516ASM

- Centerless valve refacer
- Centerless workhead for best concentricity
- Infinite variable workhead rotation speed
- Includes micrometer butt grinder and chamfer attachment
- Automatic or manual feed

COOL BOSS

coolboss.com | 855-223-2665

coolee™



COOLEE

- Dual, high-airflow brushless cooling fans
- High-density, abrasion-resistant fabric for leak-proof performance
- Super-polymer rechargeable 10,000 mAh lithium-ion battery
- Detachable shoulder strap
- 14 quarts of cooler space
- Bluetooth stereo speakers
- Shielded impeller water pump delivers boosted efficiency at low noise levels
- Optimized air balance fan blades deliver efficient airflow

CTECH MANUFACTURING

ctechmanufacturing.com | 715-355-8842



ECONO GARAGE CABINET

- Perfect for any garage or race shop
- Constructed with corrosion-resistant aluminum
- Features gasket-sealed countertop, latching doors and drawers, and adjustable feet
- Available in base, overhead, wall, and closet cabinet configurations



CONFIGURABLE CARTS

- Design custom toolboxes and pit carts online using an interactive 3D online cart builder
- Select Caster Cart, Mini Cart, and Worktop Cart chassis templates to customize
- Adjust cart dimensions, powder coat finish, options, drawer stacks, and more



TOOLGRID BUNDLES

- The easiest way to kickstart your tool organization project
- A wide variety of tool holders, containers, and other items are available
- System is compatible with any drawer and infinitely adaptable to changing tool sets
- Bundles are conveniently packaged and ready to install



BLACKLINE LITE-DUTY BENCH

- Popular for race trailers and workshops
- Lightweight, durable, and stylish
- Bench folds down to save space when not in use
- Pick up and move the bench from one mounting point to another thanks to button mounting technology

GIANT FINISHING

giantfinishing.com | 708-343-6900



GIANT MODEL W-5

- 5 cu. ft. vibratory tub
- 19-inch x 35-inch process chamber
- Standard 1-1/2 hp motor with 110 V 1 PH variable frequency drive
- Steel hinged sound enclosure
- 10-gallon fabricated settling tank



GIANT MODEL GB-3

- 3 cu. ft. vibratory bowl with internal separation
- 9-inch process channel
- Standard 1-1/2 hp motor with 110 V 1 PH variable frequency drive
- Interchangeable screen deck



GIANT SLURRY BLASTER

- 48-inch x 36-inch process chamber
- 12-gauge stainless steel construction
- Laser-cut and hand-welded dual-access double-panel doors
- Window wiper with control knob
- Fresh water rinse hose
- Ergonomic blast gun



GIANT GCB CENTRIFUGAL BARREL FINISHER

- Minimal process times
- Variable frequency controls
- Variety of barrel option configurations to choose from
- Safe and easy operation

JACKPAK

jackpak.com | 833-522-5725

JACKPAK®



JACKPAK ULTRA2500A

- 4-in-1 design features a 2500A jump starter, 300-lumen LED flashlight, 150 PSI air inflator, and a 20,500 mAh power bank
- Heavy-duty, color-coded copper clamps are keyed to prevent reverse polarity connection
- Supports USB 3.0 fast charging
- 76 wh lithium-polymer rechargeable battery

MAXJAX

maxjax.com | 844-629-5291

MAXJAX[®]



MAXJAX M7K

- Clear undercar access without relying on a permanent installation
- Safely handles up to 7,000 pounds
- Adjustable lifting arms and stackable adaptors enhance overall arm positioning
- Low-profile arms fit under the lowest compact and sport vehicles
- Maintenance-free slide blocks will last virtually the life of the lift

QUICKJACK

quickjack.com | 888-262-3880

QUICKJACK™



QUICKJACK 7000TL

- Automatic safety locks engage at full-rise and mid-rise
- Increased lifting height
- New TL models offer an additional 3 inches when compared to previous models
- One-handed operation controls the raising and lowering of your QuickJack
- Safely lifts up to 7,000 lbs
- Effortlessly raises passenger cars, light-duty trucks, and SUVs

SERDI CORPORATION

serdimachines.com | 770-493-8220

SERDI



PROFILE

- Ease of use, speed, and accuracy brought to a whole new level
- Extremely versatile machine appropriate for machining any kinds of cylinder heads
- Conversational CNC single point valve seat machine
- Triple air cushion centering
- Large valve seat capacity 0.55 to 4.72 inches



SERDI S4.5

- Very accurate, all-purpose machine to ream the guides and cut the valve seats
- Triple air-float centering system and powerful spindle with built-in motor
- Heavy stroke motor spindle
- Triple air cushion centering
- Large valve seat capacity 0.6 to 4.72 inches



SERDI S3.5

- High-precision machine especially designed for multi-valve cylinder heads
- Workhead with triple air-float centering system and built-in spindle motor
- Perfect machine for the most demanded motorcycle and automotive multi-valve cylinder heads
- Achieves excellent levels of concentricity even in guide sizes as small as 3 mm/0.12 inches.



SERDI S2.0 ES

- Best budget machine designed on the working principle of the double air-float centering system
- Built-in motor spindle delivering powerful torque
- Very high rigidity machining head and frame, being able to carry any conventional heads

SUNNEN PRODUCTS COMPANY

sunnen.com | 800-325-3670



SV-35 CYLINDER HONE

- Next generation of the legendary Sunnen Cylinder King line
- Constant crosshatch from top to bottom of the bore for optimum ring sealing
- New Sunnen2 system controls for simple setup and operation
- Automatic, unattended bore-to-bore honing



SV-15 CYLINDER HONE

- Large touchscreen with easy-to-use controls
- Fast, easy setup
- Up to 100 setups can be saved with USB backup
- Bore profile display allows honing to end specs without stopping to gage bores



SH-4000 CON ROD HONE

- Automatically hones connecting rods to size
- Easy to set up and operate with minimal operator training
- Rods are honed square with the face, round and straight
- Can also be used for piston pin bores, small ending cylinders, and other parts



CH-100 LINE HONE

- CH-100 is the industry standard for align honing of main bearing bores
- Fast, easy setup
- Brings main bores back to perfect alignment with minimal stock removal
- Hones a wide variety of blocks: inline, V6, V8, and diesels



**ABS PRODUCTS
PROFESSIONAL SERIES
HANDHELD POLISHER**

- Must have for machine shops, motor rebuilders, and engine repair shops
- Makes polishing your crank, cam, and rack & pinion shafts simple, easy, and cost effective
- Available sizes 64-inch or 72-inch models
- Replacement belts in various widths and finishing available

Contact: 714-671-0728
abs-products.com



**ADVANTAGE LIFTS
AL-12C 12,000-POUND,
TWO-POST LIFT**

- Suitable for lifting cars, SUVs, trucks, and cargo vans
- Wide drive-through between posts
- Two-stage arms and 4.5-inch pads
- Stack-on truck adapters
- ETL recognized 220V power unit
- Five-year warranty

Contact: 805-795-3778
advantagelifts.com



**CLAY SMITH CAMS
CLAY SMITH CAMSHAFT
DEGREE KIT**

- These complete kits include all the components you need to degree your camshaft
- Large, easy-to-read degree wheel
- Seven-inch magnetic dial indicator base
- Three varying solid lifters for common American engines
- Lightweight ball-and-cup pushrod
- Enclosed in a blow-molded case
- "Lobe Center Method" highly recommended

Contact: 714-523-0530
claysmithcams.com



**CTEK
CTEK CS FREE BATTERY
CHARGER**

- Four-in-one multi-functional portable charging unit
- Adaptive Booster - Works out the safest way to power up your battery to get you going quickly
- Battery Charger - Connect to a power outlet, a solar panel kit or 12V battery
- Smart Maintainer - Keeps your battery in peak condition
- Hi-tech Power Bank - Tops up your laptops, smartphones, tablets, and cameras

Contact: 330-283-7879
smartercharger.com



**NEO
SYNTHETIC
GEAR OILS**

Neo Synthetic Oil
2871 Gundry Ave.
Signal Hill CA 90755

Ph: 1-562-595-7208
Email: Neooilusa@gmail.com

NeoSyntheticoil.com



FOR SHOW & GO!



GEN3 ONYX TURBO SHIELDS



**ONLY TURBO SHIELD ON THE MARKET
WITH A FULL 2 YEAR WARRANTY!**



800.264.9472

DesignEngineering.com



SECTION 4 MACHINERY, TOOLS & EQUIPMENT



CUTTING EDGE AUTOMOTIVE SOLUTIONS 3/8-INCH DR SOCKET SET

- Metric Sockets 12pt; 6, 7, 8, 9, 10, 11, 12, 13, 14, 15, 16, 17, 18, 19, 21, 21, & 22 mm
- SAE Sockets 12pt; 1/4, 5/16, 3/8, 7/16, 1/2, 9/16, 5/8, 11/16, 3/4, 13/16, & 7/8 inch
- Metric Deep Sockets 6pt; 10, 11, 12, 13, 14, 15, 16, 17, 18, & 19 mm
- SAE Deep Sockets 6pt; 3/8, 7/16, 1/2, 9/16, 5/8, 11/16, & 3/4 inch
- Spark Plug Sockets; 5/8 & 13/16 inch
- 90T Ratchet; Flex Handle, 200 mm
- Extension Bars; 75 & 250 mm; Universal Joint

Contact: 855-839-2626
ceasusa.com



DRC RACE PRODUCTS VALVE SPRING REMOVAL TOOL

- Designed to work specifically with the high spring pressures of today's engines
- Featuring a detachable handle, it will safely remove the valve springs while the cylinder heads are on the motor
- Pushes the valve spring straight down and makes a normally tough job an easy one
- Available in standard and custom configurations

Contact: 570-658-3515
drcraceproducts.com

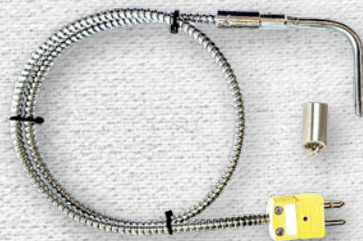

EXHAUST GAS TECHNOLOGIES SUPER X - DYNAMOMETER EGT SENSORS

- Super X tip is now available for any dynamometer application
- Specifically built for applications that require accurate repeatability, long life, and crazy fast response
- Long lifespan
- Unmatched durability
- Accuracy you can believe in
- Compatible with all dynamometers

Contact: 909-548-8100
exhaustgas.com



FEDPRO TUB O' TOWELS HEAVY DUTY CLEANER & DEGREASER SPRAY

- Takes the power of Tub O' Towels Heavy Duty Cleaning Wipes into a spray format to get in the nooks and crannies of grease and grime
- Dynamic cleaner can take on any heavy duty mess, from paint splatter to smeared caulk
- Removes grease, oil, tar, stains, paint, caulk, epoxies, dirt, and grime easily

Contact: 216-464-6440
fpcintl.com



GEDORE TOOLS
3/8-INCH DRIVE TSN SLIPPER TORQUE WRENCH

- Reads 15 to 55 Nm
- Slipping function makes it impossible to over-torque
- Ergonomic and pleasant non-slip rubber grip
- Lightweight yet robust and corrosion-resistant design
- Automatic resetting to starting position

Contact: 843-270-3966
klann-online.de



GOODSON TOOLS & SUPPLIES
MANUAL VALVE SPRING BENCH

- Remove and install valve springs on heads with recessed springs
- Creates 550 pounds of force with 45 pounds of exertion
- Includes 28-mm diameter spring adaptor
- Frame tilts up to 25° in either direction for canted valves
- Full cylinder head support is adjustable from 0° to 45°

Contact: 507-452-1830
goodson.com

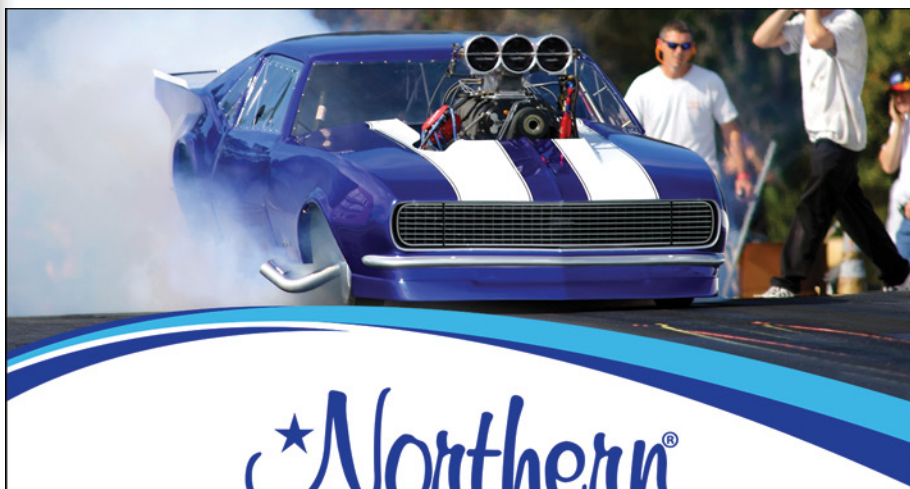

Northern[®]
RADIATOR

Trust Northern to Keep Things Cool While You're Heating Up the Track!

Whatever your race application needs, Northern is up for the cooling challenge! Whether it's circle track, dirt, off-road, or drag racing, we've got high quality radiators, fans, shrouds, and more to help keep your temperature in check so you can do what you do best.

Need help finding the right products to fit your application?

Give us a call and let our knowledgeable customer service staff guide you to the right products to meet your cooling demands.



Call or Visit Us Online Today!

1-800-328-8900 • www.NorthernRadiator.com

H-P H-P Products
Engineered Tube Bends

YOUR GO-TO CUSTOM TUBE BENDING & FABRICATION EXPERTS

- CNC BENDING
- LASER TUBE CUTTING
- END-FORMING
- WELDING
- AND MORE!

Instagram: [HPPRODUCTSETB](https://www.instagram.com/HPPRODUCTSETB)
Website: H-PTUBEBENDS.COM
Email: ETBSALES@H-PPRODUCTS.COM

BC

LS1
OR
LS7
SNOOT

1500+
WHP

★ DOUBLE
KEY WAY

★ LW PROFILING

STROKES 4.000"
4.125"
4.250"

COYOTE DEVELOPMENT

BRETT LA SALA / FFRE
6.33@224MPH



619.749.9018

RUNBC.COM



HERITAGE-CRYSTAL CLEAN AQUEOUS PARTS CLEANERS

- Crystal Clean's aqueous parts washers incorporate the newest technologies for safe and effective cleaning options you can rely on
- Crystal Clean's proprietary Mirachem line of aqueous chemistries are environmentally friendly, water-based cleaning solutions formulated to clean everything from carbons, grease, oils, paint, and more

Contact: 877-938-7948
crystal-clean.com



HUTH BEN PEARSON INTERNATIONAL HUTH DUAL-HEADED TUBE EXPANDER - MODEL 1674

- Portable expander with two powerful cylinders
- 3 1/2 inches produces 25,000 lbs. expanding power, 5 inches produces 49,000 lbs.
- Expand tubing anywhere for flexible, creative, affordable tube connecting, form slip joints, flares/flat flares, and ball joints
- Expanding capacity from 1 to 6 inches, up to 12 inches with custom tooling
- Includes easy-to-use Accu-Sizer system

Contact: 800-558-7808
huthbenders.com



LARSON SYSTEMS VALVE SPRING TESTER

- High-precision spring tester ideal for valve springs used in go-kart or snowmobile engines all the way up to nitro-injected Top Fuel engines
- Standard 5-inch range and stroke – 2-inch or 4-inch Ø platforms
- Standard 0.001-inch length resolution
- Load capacities: 200 lbf; 750 lbf; 1,500 lbf

Contact: 763-780-2131
larsonsystems.com



LINDE GAS & EQUIPMENT LANCER COBOT

- UR10e universal cobot
- Programmable by pendant or by hand
- 60 in. x 48 in. work area with 5/8 in peg hole compatibility
- Linear, circular and weave weld motion
- 2 in. x 2 in. grid CNC precision, hole diameter 0.625 (5/8) in.
- 500 amp BINZEL air-cooled welding torch

Contact: 800-225-8247
lindedirect.com



MASTERCAM MASTERCAM 2024

- Elevate your machining experience with Mastercam 2024, the latest version of the world's leading CAD/CAM software
- Increase productivity with B-Axis Contour Enhancements
- Enhance performance with Turret Mounted Angled Milling Heads
- Discover progress in Process Hole Improvements
- Improve toolpath motion by detecting undercut stock when machining
- Maximize engagement with Dynamic Motion

Contact: 860-875-5006
mastercam.com



MB METAL TECHNOLOGIES PATMARK - PORTABLE PIN MARKER

- Portable, battery-operated, dot pin marker
- Can mark on everything from plastics to hardened metals up to 62 RC
- Easy-to-use Windows-based software, as well as Android and iOS compatible app-based software
- Available in three marking window sizes: 15 mm x 15 mm, 15 mm x 33 mm, and 20 mm x 80 mm

Contact: 855-897-1439
mbmetaltech.com

NEW Titanium Valves

QUALITY - PRECISION - PERFORMANCE

Erson Cams introduces a cutting-edge line of Titanium Racing Valves, designed to take your engine performance to the next level. These valves represent the pinnacle of engineering excellence, meticulously crafted to meet the demands of high-performance racing applications.

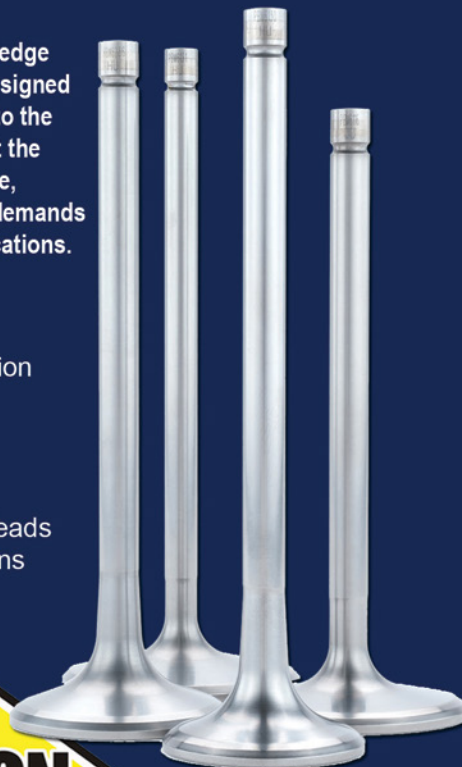

Erson Titanium Valves

- One piece forged Construction
- Precision Machining
- Chromium Nitride Coated
- Radius keeper groove
- Hardened Steel Tip
- Compatible With Specific Heads
- Significant Performance Gains



Follow us on:



PBM Performance Products
 ERSON Cams
 World Products

pbm-erson.com 800-641-7920



INTRODUCING THE 2020 REDESIGNED DIESEL ROD LINEUP

- DESIGNED FOR 2500HP
- INCLUDES POCKET UNDERPIN END
- AVAILABLE FOR ALL BIG 3: DURAMAX, CUMMINS, & POWERSTROKE



949.567.9000

WWW.CP-CARRILLO.COM

Behrent's
Performance Warehouse

— WHAT WE DO... —

**WHOLESALE
DISTRIBUTION**

— WHAT SEPARATES US FROM THE PACK... —

THE TOP BRANDS
THE LATEST PRODUCTS FROM INDUSTRY LEADERS

MEGA INVENTORY
WHAT YOU NEED, WHEN YOU NEED IT

RELIABLE SHIPPING
SAME DAY SHIPPING - AIR, GROUND, FREIGHT

TECHNICAL SERVICE
QUESTIONS? OUR SALES TEAM IS COMPRISED
OF RACERS - NOT ORDER TAKERS!



— THE EXCLUSIVE HOME OF —
PANELfast

THE LEADER IN
QUARTER-TURN
FASTENERS &
MUCH MORE!



Behrents.com
TOLL FREE: 877-372-2348



LOCATED IN FLORIDA, NY | SALES@BEHRENTS.COM

SECTION
4

**MACHINERY, TOOLS
& EQUIPMENT**



**PERFORMANCE CBN
VALVE GUIDE REAMERS -
CARBIDE**

- New solid carbide valve guide reamers for bronze guides
- Standard and specials available
- The company's shanks are a half-inch longer than most on the market, for easier use
- Check out our pricing

Contact: 269-217-4262
performancecbn.com



**PIT PAL PRODUCTS
ALUMINUM FOLDING WORK
TABLE**

- Heavy-duty folding table for all of your engine work
- Great in the pits or in the shop
- Available in three sizes
- Lower shelves available separately for more storage
- Also have wall-mount, fold-down tables available

Contact: 847-872-7257
pitpal.com



**PRO ULTRASONICS
PRO 4230LT**

- Large capacity ultrasonic cleaning system with agitating lift table, dual filtration, surface skimming, PLC touch screen, and 1,000-pound capacity
- Automatically cleans all of your engine parts—heads, blocks, cranks, and small parts—hands-free
- Dedicated to cleaning all of your parts while you focus on rebuilding and taking care of your customer

Contact: 828-584-1005
proultrasonics.com



**QUANTUM MACHINERY GROUP
ELEVATING MANUFACTURING
WITH PREMIER EQUIPMENT**

- Discover European craftsmanship with Siegmund Welding Tables, Nargesa Metalworking Machinery, and MACC Saws at Quantum Machinery Group
- Offering high-quality, durable equipment for precise metalworking, ensuring exceptional performance
- Quantum Machinery Group propels businesses to manufacturing excellence, merging tradition and innovation with every piece of machinery supplied

Contact: 704-703-9400
quantummachinery.com



RACE TOOLS DIRECT
8,000 POUND FOUR POST
STORAGE LIFT

- Great for working on cars or storage to maximize garage space
- 8,000-pound capacity
- 10 locking positions
- Aircraft quality cables rated at 14,500 pounds
- Dual safety system
- Internal lock ladder design
- Non-skid steel diamond plate runways
- Adjustable lock ladders
- Single point lock release
- Durable powder-coat finish

Contact: 440-941-8533
racetoolsdirect.com



RMC ENGINE REBUILDING EQUIPMENT
RMC ETS100

- The RMC-ETS100 is an accurate and dependable solution to systematically test oil pressure, oil flow, compression, torque to turn, cooling system leak down, cylinder cancelation and cam timing advance
- Identify the most common mechanical malfunctions encountered by engine builders, assuring your products will exceed your customers' expectations

Contact: 989-754-3611
rmcengine.com



UNLEASH THE POWER

SJPC
 SCOGGIN DICKEY PARTS CENTER

YOUR SOURCE FOR
 PERFORMANCE SINCE 1929.



CHEVROLET

PERFORMANCE
 VEHICLES / PARTS / RACING



GENUINE
 PARTS

ACDelco

VISIT US AT BOOTH #4321

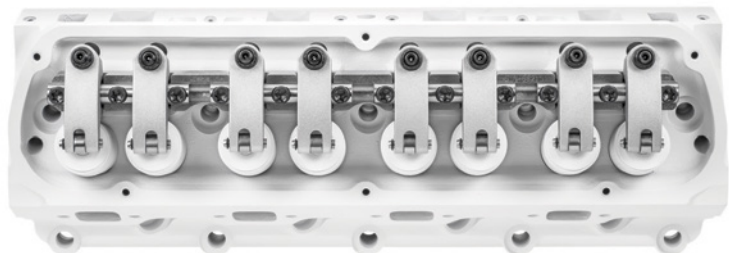

SPORTSMAN ALUMINUM SHAFT ROCKERS

JESEL
 VALVETRAIN INNOVATION

Designed for naturally aspirated applications, Jesel Sportsman Series rocker systems have proven themselves to be the ultimate replacement for inadequate stud rocker assemblies on OEM and aftermarket cylinder heads. No modification. No aggravation.

For additional product details, visit us online at Jesel.com or contact us by phone at 732.901.1800



PROFORM

HERE'S THE SKINNY ON CHEVY SLIM-FIT RADIATOR SYSTEMS

RADIATOR + SHROUD + FAN = 4 INCHES THICK!

"Third Tank" Flow-Through Allows coolant to flow through the entire radiator nearly eliminating dead space.

Revolutionary Slim-Fit Core (US Pat. 9,212,598)
The fan and motor are mounted to a plate inside the core.

ProformParts.com/chevy-slim-fit



SERVICE PRECISION GRINDING DRILL SHARPENER, MODEL 82B

- Sharpen drills quickly, easily, and accurately from 1/16-inch to 1 1/2-inch (1.6 mm to 38 mm) diameter
- Optionally sharpen taps, reamers, and end mill faces, from 3/16 inch or #10 (5 mm) to 1 inch (25.4 mm)

Contact: 315-776-9602
drill-grinder.com

All sets precisely matched using Fuel Injector Clinic's proprietary Data Match Technology, the most complete flow matching and latency value information available in the industry.

**DATA
MATCH
TECHNOLOGY**

NEW 1200cc Injector with USCAR Plug

- Compatible with ALL Fuels
- Competitively Priced
- Drop In Fitment
- Great Tuning Data
- Lifetime Warranty
- Bosch Injector
- Order Part Number 1200H-D



FIC
FUEL INJECTOR CLINIC

The leader in high flow rate performance fuel injectors with the latest injector technology for performance engines. Sizes from 365cc to 2150cc—32lb to 200lb. Dealer programs available.

fuelinjectorclinic.com • 561.427.0082



SHOPSABRE SIDEKICK PLASMA MACHINE

- Industrial small CNC plasma cutter at entry-level cost
- FEA engineered, designed, and manufactured in the USA
- Constructed of the heaviest frame in the light industrial class
- Machine frame is built to handle the cutting forces of routing and heat tolerances of plasma
- High-torque, high-accuracy motors with Encoder Technology on X, dual Y, and Z axis

Contact: 952-461-4570
shopsabre.com



**TOPDON USA
V2200PLUS**

- The V2200Plus is a 2-in-1 jump pack and battery tester that takes on the unexpected
- Offering 35 jumps on a full charge, smart clamps to protect against common safety hazards, and features a 300-lumen LED light
- A built-in Bluetooth module supports 12V battery tests by pairing an app with Bluetooth

Contact: 317-488-0273
topdon.us



**TRUMPF
TRUARC WELD 1000**

- Quick programming, reliable welding
- The complete package when getting started with cobotic arc welding even with high mix, low quantity production

Contact: 860-674-8226
us.trumpf.com

3" Tube Aluminum Driveshafts
3-1/2" Tube Aluminum Driveshafts
3" Tube Steel Driveshafts
2-1/2" Tube Steel Driveshafts

pro-life **Lightweight Harmonic Balancers**
 * All Steel
 * All Aluminum
 * Aluminum With Steel Sleeve

pro-life **Lightweight Quick Change Gears**
 .875 Wide
 Only 2.9 Lbs.

COLEMAN
 colemanracing.com
 N1597 US41
 Menominee, Mi 49858
 Phone: (800) 221-1851
 Email: sales@colemanracing.com

[f](http://facebook.com/colemanracing)
colemanracing.com

Billet REAPER
E4340 Billet Steel Crankshafts

- Manufactured from E4340 Aircraft Quality Bar Stock Material
- CNC Machined to Exacting Tolerances
- Center Counterweights
- Stress Relieved & Shot Peened
- Nitride Hardened for Superior Wear
- Large Fillet Radii on All Bearing Journals
- Lightening Holes in All Rod Journals
- Double Keyways for Dampers
- Chevrolet SB - Available with Standard or Big Block Snout
- Chevrolet LS - Counterweights Fit OE & Aftermarket Blocks
- Chevrolet LS - Include Choice of 24 or 58 Tooth Reluctor
- Chevrolet SB 3.500", 3.750" 3.875" & 4.000" Strokes
- Chevrolet LS 3.500", 3.622" 4.000" & 4.125" Strokes
- Chevrolet BB 4.000", 4.250" 4.375", 4.500" & 4.750" Strokes

HOWARDS
 cams
 & RACING COMPONENTS

HRC
HOWARDS
 RACING COMPONENTS

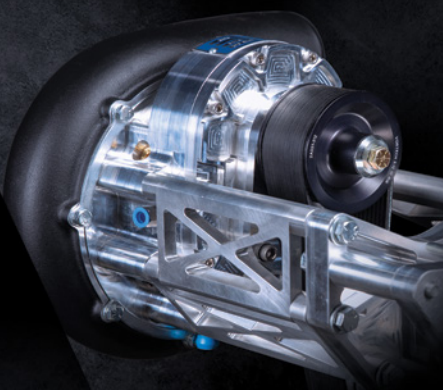
VORTECH
SUPERCHARGERS



MEET THE NEW V-13

**BIG POWER IN A SMALL PACKAGE,
WITH THE 1,500+ HP CAPABLE
V-13 94C SUPERCHARGER**

INTERNAL STEP-UP RATIO: 3.45:1
MAX SPEED: 65,000 RPM
MAX BOOST: 35+ PSI
MAX FLOW: 1,950+ CFM
MAX POWER: 1,500+ HP
PEAK EFFICIENCY: 78%

BOOST YOUR PERFORMANCE TODAY
805.247.0226 | vortechsuperchargers.com

[f](#) [t](#) [i](#) [o](#) #POWEREDBYVORTECH

 CARB COMPLIANCE: This product is not available or legal for sale or use in California. Please contact Vortech Sales for more information.



**30 YEARS OF
LEGENDARY EFFICIENCY,
PERFORMANCE & POWER**



VAN NORMAN MACHINE INDIA PVT LTD NEW VALVE SEAT AND GUIDE MACHINE

- Newly developed next generation high precision valve seat and guide machine
- Offers live or fixed pilot system
- Automatic seat cutting, reaming and guide honing features
- Switch between manual and automatic with one touch button
- We also offer valve grinding, cylinder head surfacing, cylinder boring & cylinder honing systems

Contact: 91-99-155-44777

robinsmachines.com



DAIDO METAL
RACING BEARINGS

REVOLUTIONARY FLOATING FLANGE

Increased Thrust Capacity
Three Piece Design
Optimum End Play
Reduced Oil Leakage
Precise Grades

RACE PROVEN MATERIALS

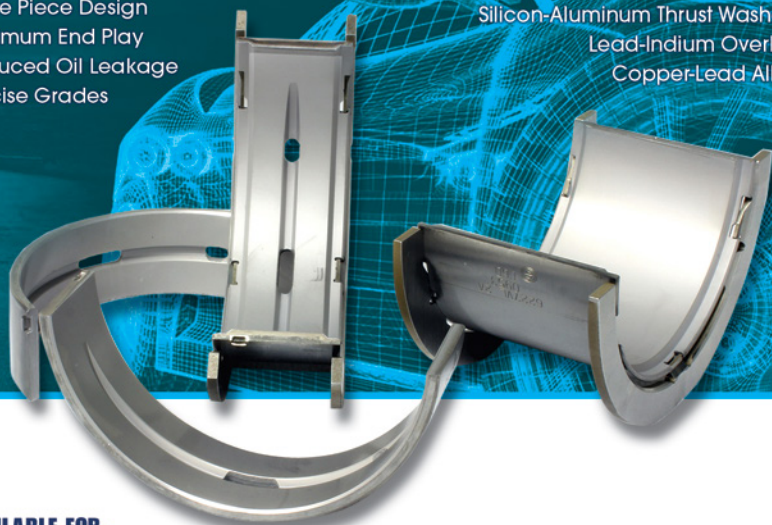
Silicon-Aluminum Thrust Washers
Lead-Indium Overlay
Copper-Lead Alloy



AVAILABLE FOR:

Chevy Small Block • Chevy Big Block
GM LS1 • 426 Hemi

WWW.CALLIES.COM/DAIDO



VAN SANT ENTERPRISES VERSAMAG MAGNETIC VISE

- 4.250-inch capacity with 4.000-inch-wide jaws
- Up to 1,750 pounds of holding force
- Easy to operate three-position handle for 0%, 30% or 100% hold
- Can be used as a removable tool mount, welding fixture or drill-press vise
- Can be used in any position and includes safety strap

Contact: 641-628-3860

tricktools.com

RMC
ENGINE REBUILDING EQUIPMENT

Innovation Starts Here!

Small to Large, Gas or Diesel, Castings or Billet, RMC has the complete Turn-Key solution to maximize your efficiency and profitability.



PRI SHOW
DECEMBER 7-9, 2023, INDIANAPOLIS

EXHIBITOR
BOOTH # 5543

Call us today about Turn-Key applications for all your block machining needs. Make profit a priority! Several machine sizes and options available for your specific business. **800-248-5062** or visit our website **www.rmcengine.com**

SECTION

5

RACE TRACK EQUIPMENT & SUPPLIES

Race track operators can improve the overall experience for both drivers and fans alike with products and services devoted to the promoters' cause, including upgraded communication systems, track cleaning equipment, onsite storage, sound systems, and more.



ADVENTURE STARTS HERE

Jeep Rear Overhead Soundbars add audio layers upon your music that transforms your sound into new dimensions of expectations. Choose from either Compression Horn (with RGB LEDs or without) or Coaxial (with RGB LEDs or without) soundbar speaker models.

The MBQJ-48HRGB and MBQJ-48H feature four 8-inch Compression Horn speakers with an enclosure, while the MBQJ-48HRGB includes RGB LEDs to bring your music to life with moving colors to showcase an in-vehicle concert. Designed to directly replace the OEM rear speaker soundbar.

The MBQJ-48CRGB and MBQJ-48C Jeep Rear Overhead Soundbars feature four 8-inch Coaxial speakers with an enclosure (like the MBQJ-48HRGB), but the MBQJ-48CRGB also includes RGB LEDs.

*Available for Jeep Wrangler JL 2018 - 2023 | Jeep Gladiator JT 2020 - 2023
*Plug & Play Installation with MBQJ-STG6A | MBQJ-STG6AH



High Output Compression Horns

MBQJ-48HRGB | MBQJ-48H



Sound Quality Coaxial Speakers

MBQJ-48CRGB | MBQJ-48C



RACECEIVER

raceceiver.com | 770-287-8544



LITECEIVER IMPACT

- Impact G-Forces
- Wireless flagging
- Control the entire field with a simple button press
- Simple, rugged and rechargeable
- Rollbar mounted
- Bright flag status LEDs
- Long-range radio
- Extended range repeater option
- Encrypted channels
- The circle track, karting and offshore solution



ELEMENT

- The all-weather communications solution
- Water and dust resistant
- Eight-hour-plus internal rechargeable battery
- Safety and efficiency
- Race officials broadcast directly to drivers
- Allows faster line-ups and restarts
- Instant notifications of track conditions
- Coaches provide instant feedback



CLASSIC FUSION +

- The gold standard in communication
- Button lock
- Louder audio
- Narrow band radio compatible
- Race officials broadcast directly to drivers
- Allows faster line-ups and restarts
- Instant notifications of track conditions
- Coaches provide instant feedback
- Improves skills and overall performance



LITECEIVER

- Wireless flagging
- Control the entire field with a simple button press
- Simple, rugged, and rechargeable
- Roll bar mounted
- Bright flag status LEDs
- Long-range radio
- Extended range repeater option
- Encrypted channels
- The circle track, karting, and offshore solution



**FOD CONTROL CORPORATION
THE FOD-RAZOR MOTORSPORT
SWEEPER**

- Helps maintenance crews keep their motor speedway facilities safe and event-ready by eliminating foreign object debris (FOD) on tracks, pit roads, parking areas and adjacent surfaces
- Best-selling friction sweeper system
- Fast and effective
- Collects over 98% of small FOD objects

Contact: 800-425-8363
fodcontrol.com



**PIT-PRO CUSTOM CARTS
PIT-PRO CUSTOM GOLF CART**

- Custom golf carts built for motorsports industry
- Variety of accessories to fulfill customers' needs at the track
- All paint colors and vinyl wraps available
- Push bars, tow straps, audio, lighting, seating, and more
- 25 years in business working with racers

Contact: 317-858-1830
pitprousa.com



**RHINO TUFF TANKS
STACKABLE STORAGE &
DISPENSING SYSTEMS**

- Eliminate the hassle of handling messy 55-gallon drums or bulky steel tanks in your liquid storage area
- This system helps transform your area into a cleaner, more efficient workspace by allowing multiple fluids to be stacked vertically

Contact: 630-527-9933
rhinotufftanks.com



**SUNDOWN AUDIO
PSB-8000SB**

- Eight speaker, 300-watt amplified Bluetooth powersports soundbar
- IPX67 Rated
- Six 3-inch full-range marine-grade poly cone speakers
- Two 1.25-inch SD mylar tweeters
- Heavy-duty aluminum watertight housing
- LED backlit control panel
- Built-in DSP processor with distortion limiter
- Universal L-bracket and clamp mounting systems included

Contact: 828-459-1980
sundownaudio.com

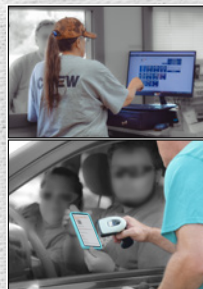

**TRACKSIDE SYSTEMS
TICKETING & EVENT
TECHNOLOGY**

- WiFi and infrastructure
- Online and on-site ticketing
- Point of sale
- Digital waivers and tech cards
- Text messaging
- Race management and much more

Contact: 330-754-3364
tracksideapp.com



**UNITED RACE PARTS
FUEL TIMER 2.0**

- The Greaves Fuel Timer 2.0 has many new modular features for the 2024 season
- IMSA rig flow integration
- Web-based software with cloud synchronization
- Virtual energy functions
- Multi-screen capability
- Advanced API integration
- Live transaction data visuals
- New temperature sensor specification
- Available to adapt to any FIA or IMSA fuel rig

Contact: 704-500-2000
unitedraceparts.com



SECTION

6

RACE SANCTIONING ORGANIZATIONS

Helping to ensure a level playing field for participants, these organizations regulate and coordinate the events and series that fall under their authority. As de facto governing bodies, they partner with member tracks, develop and enforce rulebooks, penalize infractions, run sponsorship and contingency programs, manage payouts, and work to keep drivers, crew members, spectators, and others safe while maintaining fair and equitable competition.

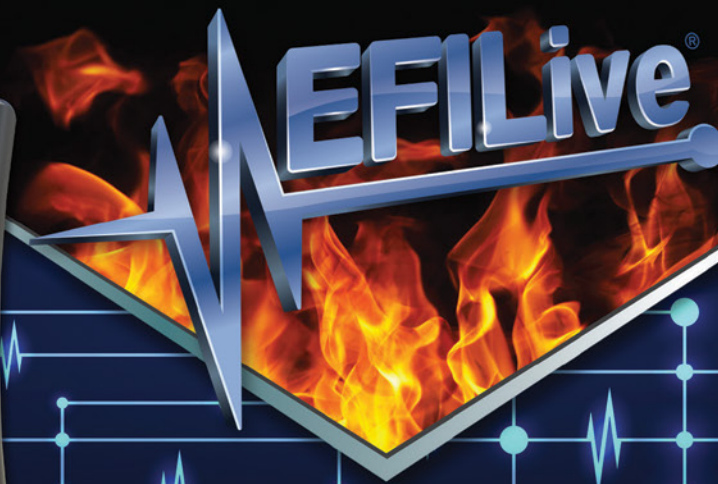

Now with Duramax L5P

UNLOCK YOUR VEHICLE'S **MAXIMUM POTENTIAL!!!**

Put the right tools in your toolbox! **FlashScan V3** from EFILive allows you to scan, data log and reprogram your vehicle for maximum performance and outstanding drivability.

FLASHSCAN V3 SPECIFICATION:

- ✓ Fully integrated Scan and Tune Tool.
- ✓ All new V8 tune file editor.
- ✓ Integrate your custom calibrations into the V8 editor.
- ✓ Light duty (CAN J1979, VPW J1850) and Heavy duty (CAN J1939) protocols.
- ✓ Supports 600 VIN Licenses.
- ✓ Large, easy to read color screen.
- ✓ Built in 512MB micro SD Card.
- ✓ Built-in audible alarms.
- ✓ Upgradable firmware.
- ✓ Vehicle input voltage - Min 9V, Max 28V.
- ✓ Battery backed real-time clock.
- ✓ Appears as a Windows USB drive.
- ✓ Built-in power supply prevents data corruption if external power supply is interrupted.
- ✓ Customize menus, colors and images.
- ✓ Read & clear DTC codes.
- ✓ High speed data logging.
- ✓ Display data while logging.
- ✓ Read & program calibration & operating system data of engine controller.
- ✓ Integrates with AutoCal V3 to deliver your own custom handheld tuning device.
- ✓ Automatic saving of trace files.

FLASHSCAN & AUTOCAL V3 COMPATIBILITY:

FlashScan V3 & AutoCal V3 can be used with the following controllers:

- » Most 2006-2021 Dodge Cummins 5.9L & 6.7L
- » Most 1998-2021 GM Gas Vehicles
- » 2001-2023 Duramax 6.6L
- » 2014-2021 Duramax 2.8L
- » Most 2007-2021 Cummins HD Controllers



FlashScan V3 with one Tuning option US\$1025.00

AutoCal V3 as low as US\$290.00*

*Quantity discounts available

www.efilive.com





BUILT FOR THE BUILDER



Included in every block:

- Honed Crankshaft Mains
- Honed Camshaft Tunnel
- Bored Cylinder Sleeves
- Cylinder Sleeve Protrusion

419-355-9304

ENERGY

MADE IN THE USA

SECTION **6**

RACE SANCTIONING ORGANIZATIONS

24 HOURS OF LEMONS

1015 Cedar St.
Santa Cruz, CA 95060
844-288-8227
24hoursoflemons.com
REGION: USA
TYPE: Endurance Races For \$500 Cars, Car Shows, Road Rallies, Sim Racing

500 SPRINT CAR TOUR

765-642-0206
jowen@andersonspeedway.com
500sprintcartour.com
REGION: IN, MI, OH, TN
TYPE: Non-wing Pavement Sprint Cars

AMERICAN CANADIAN TOUR, LTD (ACT)

105 N. Main St., Ste. 208
PO Box 1002
Barre, VT 05641
802-244-6963
trisha@thunderroadvt.com
acttour.com
REGION: CT, MA, ME, NC, NH, VT, & QC, Canada
TYPE: Late Model Sportsman Racing, Mini Stocks

AMERICAN DRAG RACING LEAGUE

204 W. Pitman St., Ste. E
O'Fallon, MO 63366
636-542-8400
info@adrlltour.com
adrlltour.com
REGION: NC, TX
TYPE: Drag Racing

AMERICAN DRAGCAR

PO Box 14976
Phoenix, AZ 85063
602-741-7809
info@usdragcar.com
usdragcar.com
REGION: AZ
TYPE: Drag Racing

AMERICAN HOT ROD ASSOCIATION (AHRA)

PO Box 309
Lascassas, TN 37085
615-580-3137
dallas@ahraonline.com
ahraonline.com
REGION: IA, MO, NC, OH
TYPE: Drag Racing

AMERICAN MODIFIED SERIES

98 Jane Ln.
Stout, OH 45684
812-216-9317
dragland44@gmail.com
americanmodifiedseries.com
REGION: IL, IN, KY, OH, TN
TYPE: Dirt Open Wheel Modified

AMERICAN RACING DRIVERS CLUB, INC. (ARDC)

419 Water St. Rear
Danville, PA 17821
570-441-4692
shannonmausteller@hotmail.com
ardcmidget.com
REGION: NC, NH, NJ, PA
TYPE: Midget Auto Racing

AMERICAN RALLY ASSOCIATION (ARA)

4910 W. 16th St.
Speedway, IN 46224
317-247-5151
ara@ara-rally.com
americanrallyassociation.org
REGION: USA
TYPE: United States Stage Rally Racing, 501(c) (3) nonprofit

AMERICAN SPRINT CAR SERIES (ASCS)

PO Box 389
Drumright, OK 74030
918-417-0624
terry@ascsracing.com
ascsracing.com
REGION: USA
TYPE: 360 Sprint Car Racing

AUTOMOBILE RACING CLUB OF AMERICA (ARCA)

PO Box 380
Temperance, MI 48182
734-847-6726
jaharris@arcaracing.com
arcaracing.com
REGION: USA
TYPE: Stock Cars

ATLANTIC COAST OLD TIMERS AUTO RACING CLUB

193 Thompson Rd.
Windsor, NY 13865
607-655-1427
johnjwuples@gmail.com

acotnews.org

REGION: ME, NY, PA

TYPE: Antique Race Cars

AUSTRALIAN NATIONAL DRAG RACING ASSOCIATION

287 Payneham Rd.
Royston Park, SA 5070
Australia

011-61-8-8271-5355

info@andra.com.au

andra.com.au

REGION: Australia

TYPE: Drag Racing

AUTO VALUE BUMPER TO BUMPER SUPER SPRINTS

109 N. Broadway
Cassopolis, MI 49031
269-580-2461

tom@supersprints.com

supersprints.com

REGION: MI, OH

TYPE: 410 Asphalt Winged Sprint Car Racing

AUTOMOBILE COMPETITION COMMITTEE US/FIA (ACCUS)

825 Ballough Rd., Ste. 200-C
Daytona Beach, FL 32114

386-506-0140

accusfia.us

REGION: USA

TYPE: International Sporting Sanctioning Authority For The US

BADGER MIDGET AUTO RACING ASSOCIATION

2764 Egge Rd.
Sun Prairie, WI 53590
847-840-1344

info@bmara.com

bmara.com

REGION: IL, WI

TYPE: Midget Racing

BAY CITIES RACING ASSOCIATION (BCRA)

2218 Bluffs Ct.
Livermore, CA 94551
510-376-3338

bcraracing@gmail.com

bcraracing.com

REGION: CA

TYPE: Midgets Racing, Lightning Sprints & Vintage Division

BEST IN THE DESERT

3475 Boulder Hwy., Ut. B
Las Vegas, NV 89121
702-457-5775

bitd@bitd.com

bitd.com

REGION: AZ, NV

TYPE: Off-Road Racing

BIG 8 LATE MODEL SERIES

PO Box 1000
Rockford, IL 61105

815-633-1500

info@big8latemodels.com

big8latemodels.com

REGION: IA, IL, WI

TYPE: Short Track

BMW CAR CLUB OF AMERICA

2350 Hwy. 101 S.
Greer, SC 29651

864-558-5936

kchulkas@bmwcca.org

bmwccaclubracing.com

REGION: USA

TYPE: Car Club

BUCKEYE OUTLAW SPRINT SERIES (BOSS)

2177 Lunbeck Rd.
Chillicothe, OH 45601

740-703-3768

sprinter14@hotmail.com

bossfastsprints.com

REGION: IN, OH, PA

TYPE: Sprint Cars

CALIFORNIA LIGHTNING SPRINTS

24325 Crenshaw Blvd., #146
Torrance, CA 90505

sdaloisiosports@gmail.com

racecls.com

REGION: CA

TYPE: Sprint Cars

CANADIAN AUTOMOBILE SPORT CLUBS - ONTARIO (CASC-OR)

7250 Keele St., Ste. 413
Concord, ON L4K 1Z8

Canada

416-667-9500

office@casc.on.ca

casc.on.ca

REGION: ON, Canada

TYPE: Sports Car Racing

CORE RACE PRODUCTS

BASED IN MOORESVILLE, NC

PROUDLY SERVING THE RACING COMMUNITY'S PARTS NEEDS FOR 15+ YEARS FROM HARTING TO CUP. WE OFFER PARTS TO SUIT YOUR NEEDS TO WIN!

TRUE TWIST SWAY BAR LOAD TOOL.

HURRICANE WHEEL FANS

KARTING, LATE MODELS (DIRT AND PAVEMENT), ARCA, TRUCKS, CUP PARTS MANUFACTURER

facebook.com/coreraceproducts

[704] 886-7490

HIGH PERFORMANCE METALS FOR THE RACING INDUSTRY



Service Steel Aerospace is committed to providing the high performance racing industry and other critical application industries throughout the world with:

- ▶ Alloy steel
- ▶ Maraging steel
- ▶ Titanium
- ▶ Stainless steel
- ▶ Nickel based super alloy
- ▶ Invar

SSA performs a wide array of value-added processing services designed to meet the specific needs of our customers.

Our commitment to quality and service has made SSA a leader in the industry for over 40 years.



SERVICE STEEL AEROSPACE CORP.
ssa-corp.com

Eastern US: 800-882-6358
Western US: 800-426-9794

SECTION 6

RACE SANCTIONING ORGANIZATIONS

CAROLINA CLASH SUPER LATE MODEL SERIES

129 Oakvale Dr.
Easley, SC 29640
864-238-2254
marion@carolinaclash.com
carolinaclash.com
REGION: NC, SC
TYPE: Dirt Super Late Model Racing

CARS TOUR

136 Bridle Path Ln.
Mooresville, NC 28117
704-662-9212
admin@carsracingtour.com
carsracingtour.com
REGION: NC, SC, VA
TYPE: Super Late Models, Late Model Stock Cars

CHAMP CAR ENDURANCE SERIES

116 Mountain View Ln.
Arrington, VA 22922
812-431-7716
info@champcar.com
champcar.org
REGION: USA
TYPE: Endurance Road Racing

CHAMPION RACING ASSOCIATION

PO Box 41426
Nashville, TN 37204
812-883-0455
luckett@cra-racing.com
cra-racing.com
REGION: GA, IN, MI, OH, TN
TYPE: ASA/CRA Super Series Template Super Late Models, JEGS/CRA All-Stars Tour Template Crate Late Models, CRA Late Model Sportsman, CRA Street Stocks

COMMISSION INTERNATIONALE DE KARTING-FIA (CIK-FIA)

2 chemin de Blandonnet
1215 Geneve 15
Switzerland
41 0 22 306 1080
fiakarting.com
REGION: Europe
TYPE: Karting

COMP CAMS SUPER DIRT SERIES

802 Third Ave.
Conway, AR 72032
sully1888@gmail.com
compdirt.com

REGION: AR, LA, MS
TYPE: Super Late Model Racing in the South

CRATE RACIN' USA

PO Box 195
Lincoln, AL 35096
678-719-8888
crateracinusa@gmail.com
crateracinusa.com
REGION: AL, FL, GA, KY, LA, MS, TN
TYPE: Crate Motor Dirt Late Model Racing

CRS SUPER TRUCK SERIES

14340 Gaskill Dr. NE
Alliance, OH 44601
216-217-5038
coyotebilly26@yahoo.com
facebook.com/groups/252692378499210/
REGION: IN, MI, NC, OH, WV
TYPE: Pickup truck/ute racing

DIRTCAR RACING

7575-D W. Winds Blvd.
Concord, NC 28027
704-795-7223
dirtcar.com
REGION: DE, FL, IA, IL, IN, KY, MI, MO, NE, NM, NY, OH, PA, SC, SD, TX, WI, WV
TYPE: Dirt Late Model Series

EMPIRE SUPER SPRINTS (ESS)

91 Ellen St.
Oswego, NY 13126
315-342-3933
chuckm@empiresupersprints.com
empiresupersprints.com
REGION: NY & ON, Canada
TYPE: Winged 360 Sprint Car Racing

ENGLEWOOD RACING ASSOCIATION

7473 W. Laurel Ave.
Littleton, CO 80128
303-947-8806
erasupermodifieds.wix.com/home
REGION: CO
TYPE: Super Modifieds

FASTRAK RACING SERIES

312 Greens Crossing Rd.
Richmond, KY 40475
859-893-7627
bill@fastrakracing.com
fastrakracing.com
REGION: GA, KY, VA, WV
TYPE: Crate Late Models, Dirt Late Models, Super Late Models

FEDERATION INTERNATIONALE DE L'AUTOMOBILE (FIA)

8 place de la Concorde
75008 Paris
France
33 1 4312 44 55
fia.com

REGION: Worldwide

TYPE: Formula 1, Formula E, World Rally

FLORIDA POWERBOAT CLUB

1214 SW 6th St.
Pompano Beach, FL 33069
954-545-1414
admin@flpowerboat.com
flpowerboat.com

REGION: FL

TYPE: High Performance Speed Boats

FORMULA DRIFT

2161 Gundry Ave.
Signal Hill, CA 90755
562-901-2600
info@formulad.com
formulad.com
REGION: USA, Canada, Japan
TYPE: Drifting

FORMULA PRO USA WESTERN CHAMPIONSHIPS

711 S. Carson St., Ste. 4
Carson City, NV 89701
888-977-7885
info@exclusiveracing.com
formulaprousa.com

REGION: CA, OR, UT

TYPE: Open Wheel Road Racing

FORMULA RACE CAR CLUB OF AMERICA, LLC (FRCCA)

160 Flying Point Rd.
Freeport, ME 04032
201-665-8682
frcca2014@gmail.com
formularacecarclubofamerica.com

REGION: MA, NY, PA

TYPE: Formula Car Racing

FORMULA RACE PROMOTIONS

1 Stiles Rd., Ste. 105
Salem, NH 03079
855-722-3377
REGION: CT, GA, NJ, OH, PA, WI
TYPE: Formula Car Racing

Legendary Protection



- Broad protection throughout the entire RPM range.
- No Maintenance or tuning & SFI Certified.
- Trusted by leading engine builders and race teams.

SRT 6.2L Engine
Aluminum damper
P/N 840302 [P/N 910302
11% Underdrive]

sfi SFI FOUNDATION INC.



Made in the USA | Fluidampr.com | 716.592.1000

CUSTOM & SHELF STOCK
HIGH PERFORMANCE PISTONS

OVER 40 YEARS OF
RACER TRUSTED
DURABILITY.



Still independently owned.
Still family operated.
Still made in the U.S.A.
SINCE 1979!

ROSS
racing pistons



(310) 536-0100
SALES@ROSSPISTONS.COM
ROSSPISTONS.COM

PTB Performance Tube Bending, Inc.
Custom Tube Bending & Fabrication

CUSTOM TUBE BENDING AND FABRICATION



MANDREL BENDING

- STAINLESS STEEL
- ALUMINUM
- MILD STEEL

FROM 1/4" OD TO 6" OD
WE BEND IT ALL

**PURCHASE TUBE SOLUTIONS FOR
THE MASTER FABRICATOR**



MANDREL BENDS - COLLECTORS - FLANGES
FLEX PIPES - O2 SENSOR - V BAND
PRIVATE LABELING AVAILABLE



**11109 JASMINE ST.
FONTANA, CA 92337
TEL: 626 939-9000**

WWW.PTBTUBEBENDING.COM

GLOBAL TIME ATTACK

2170 W 190th St.
Torrance, CA 90504
562-999-4670
info@globaltimeattack.com
globaltimeattack.com
REGION: USA
TYPE: Time Attack

GOODGUYS ROD & CUSTOM ASSOCIATION

PO Box 1932
Roanoke, TX 76262
800-777-1258
good-guys.com
REGION: AZ, CA, CO, DE, IA, NC, OH, TN,
TX, WA
TYPE: Hot Rods and Custom Car Events

HIGH LIMIT SPRINT CAR SERIES

Mooresville, NC
info@highlimitracing.com
highlimitracing.com
REGION: USA
TYPE: Winged 410 Sprint Cars

HISTORIC SPORTSCAR RACING (HSR)

One Daytona Blvd.
Daytona Beach, FL 32114
386-681-5535
info@hsrrace.com
hsrrace.com
REGION: USA
TYPE: Vintage & Historic Road Racing

INDYCAR

4551 W. 16th St.
Indianapolis, IN 46222
317-492-6526
indycar@indycar.com
indycar.com
REGION: USA
TYPE: NTT IndyCar Series and Indy NXT

INTERNATIONAL HOT ROD ASSOCIATION (IHRA)

PO Box 386
House Springs, MO 63051
855-646-4472
info@ihra.com
ihra.com
REGION: Worldwide
TYPE: Drag Racing

INTERNATIONAL KART FEDERATION (IKF)

33175 Temecula Pkwy., Ste. 233
Temecula, CA 92592
951-491-0808
info@ikfkarting.com
ikfkarting.com
REGION: USA
TYPE: Kart Racing

INTERNATIONAL MOTOR CONTEST ASSOCIATION (IMCA)

PO Box 921
Vinton, IA 52349
319-472-2201
raceimca@imca.com
imca.com
REGION: USA, Canada
TYPE: Modifieds, Sport Modifieds, Late
Model, Sprint, Stock, Compacts

INTERNATIONAL MOTOR SPORTS ASSOCIATION (IMSA)

One Daytona Blvd.
Daytona Beach, FL 32114
386-310-6500
info@imsa.com
imsa.com
REGION: USA & Canada
TYPE: WeatherTech SportsCar
Championship, Michelin Pilot Challenge,
VP Racing SportsCar Challenge, Ferrari
Challenge North America, Mustang
Challenge, Porsche Carrera Cup North
America, and Lamborghini Super Trofeo
North America

INTERNATIONAL SUPER MODIFIED ASSOCIATION

PO Box 5157
Oswego, NY 13126
315-236-0205
isma_news@hotmail.com
ismasupers.com
REGION: MI, NY, OH, PA
Type: Winged Super Modifieds

IRA OUTLAW SPRINTS

706 Green St.
McHenry, IL 60050
815-759-9269
siraprez@sbcglobal.net
irasprints.com
REGION: IA, IL, IN, MN, WI
TYPE: 410 Winged Sprints, Wisconsin
Wingless Sprints

KAJUN MINI STOCKS ASSOCIATION

1209 Hwy. 35
Pelham, AL 35124
865-206-8307
kajunministocks321@gmail.com

REGION: USA

TYPE: Modified Four-cylinder Stock Cars

KIDMODZ RACING SERIES

17047 N. 900 E.
Oakwood, IL 61858
618-314-3596
kidmodz@sbcglobal.net
facebook.com/kidmodz/

REGION: IL, MO

TYPE: Dirt Oval Youth Racing

KINGMAN ROUTE 66 STREET DRAGS

3880 Stockton Hill Rd., Ste. 103-428
Kingman, AZ 86409
928-279-9845

kingmanstreetdrags@gmail.com

kingmanrt66streetdrags.com

REGION: AZ

TYPE: Drag Racing

LUCAS OIL LATE MODEL DIRT SERIES

299 Haskell Ln., Ut. C-6
Batavia, OH 45103
951-403-1609
rick@lucasdirt.com
lucasdirt.com

REGION: USA

TYPE: Dirt Late Models

LUCAS OIL MIDWEST LATE MODEL RACING ASSN (MLRA)

18842 Speedway Dr.
PO Box 8
Wheatland, MO 65779
417-282-5984
ernie@lucasoil.com

mlraracing.com

REGION: Midwest USA

TYPE: Dirt Late Models

LUCKY DOG RACING SERIES

1155-C Arnold Dr., Ste. 365
Martinez, CA 94553
844-585-9364
info@racelucky.com

racelucky.com

REGION: USA

TYPE: North American Amateur Endurance Racing Series

Every Toolbox Needs...

WALTON™ Tap Extractors & Tap Extensions

Performance professionals have depended on high-quality Walton tools since 1908.



TAP EXTRACTORS

- Remove broken taps simply and safely, without drilling, lasers, damaged threads, scrapped parts or repair inserts.
- Available in every tap size, both inch and metric.

TAP EXTENSIONS

- Extend the reach of regular-length taps and allow tapping in deep holes and awkward locations.
- Square and round sockets conform to leading tap sizes.
- Suitable for both machine and hand-tapping.



Available as sets or individual pieces.



Tapping into good ideas for over 110 years.

(860) 523-5231
sales@waltontools.com

www.WaltonTools.com



Racing Transmission Accessories
Hi-Performance Applications

Home of the Original
"TRICK STICK"

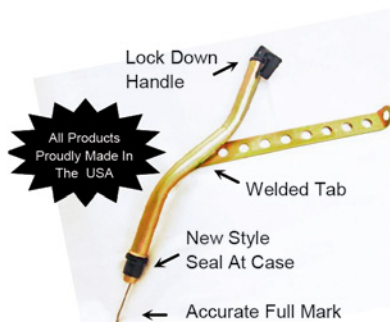

All Products Proudly Made In The USA

Fill Tube Assemblies
for automatic transmissions
Over 40 models in stock
Custom Applications
made to your specs

Engine Oil Dipstick Assemblies
now available for most applications
www.mastaperformance.com

(248) 685-8710 • FAX (248) 685-3710



BEYOND SAFETY



FIA APPROVED

WORLD-CLASS FUEL CELLS

Experience the performance you desire and the safety you deserve, no matter what you drive, when you have #ATLinside

USA FACILITY

UK FACILITY

atl@atllinc.com
201-825-1400
atllinc.com

sales@atlltd.com
+44 (0)1908 351700
atlltd.com

PF Performance
Forge, Inc.

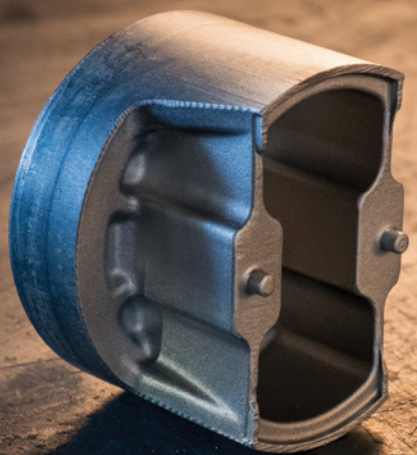

FORGED PISTONS

MADE WITH PRIDE IN THE USA

PERFORMANCE-FORGE.COM
323.722.3460

MOCAL

Fluid Control Systems

Oil Coolers - air or water to oil
Oil Thermostats - inline/sandwich
Oil Take-off's, Oil Filter Mounts
Electric Pumps & Fans
Plumbing - Hose & Fittings
-AN and Metric sizes



Importer & Distributor:

BAT Inc.

7630 Matoaka Rd
Sarasota, FL 34243
941.355.0005

www.mocalusa.com

SECTION
6

**RACE SANCTIONING
ORGANIZATIONS**

MASTERS HISTORIC RACING

35A Market PL.
Olney, Bucks MK46 4AJ
United Kingdom
347-475-6411
team@mastershistoricracing.com
mastershistoricracing.com
REGION: USA & Europe
TYPE: Historic Motor Racing

MAZDA MX-5 CUP

10101 US Hwy. 41 N.
Palmetto, FL 34221
941-845-2500
info@mx-5cup.com
mx-5cup.com
REGION: USA
TYPE: Road Racing

MID-WEST DRAG RACING SERIES

Broken Arrow, OK
539-204-4740
keith@midwestpromodseries.com
midwestdragracingseries.com
REGION: IL, MI, OK, TX
TYPE: Pro Mod Drag Racing

MIDWEST OPEN WHEEL ASSOCIATION

PO Box 584
Jacksonville, IL 62651
217-371-3653
mowasprints@gmail.com
midwestopenwheel.com
REGION: Midwest USA
TYPE: 410 Winged Sprint Cars

MIDWEST SPRINT CAR SERIES

1756 N. Shiloh Rd.
Jasper, IN 47546
812-630-3989
ebutcher@sit-co.net
msscspoints.com
REGION: Midwest
TYPE: Sprint Car Series

MIDWEST SUPER COMP SERIES

11855 Cormoy Ln.
Orland Park, IL 60467
630-201-0365
midwestsupercomp.com
REGION: IA, IL, IN, MI, WI
TYPE: Super Comp Drag Racing

MIDWEST SUPERMODIFIED SERIES

330-612-8963
loriamay7@gmail.com
midwestsupermodifieds.com
REGION: NY, OH, PA
TYPE: Short Track-Supermodified Racing

MIDWESTERN COUNCIL OF SPORTS CAR CLUBS

2410 Royal Ct.
Waukesha, WI 53188
262-442-6073
president@mcsc.org
mcsc.org
REGION: IA, IL, IN, MI, MN, WI
TYPE: Sports Car Racing

MODIFIED RACING SERIES

11 Bonney Shores Rd.
Meredith, NH 03253
603-707-0526
viperracing2@gmail.com
themodifiedracingseries.com
REGION: CT, ME, NH
TYPE: Asphalt Modified Racing

MONACO MODIFIED TRI-TRACK SERIES

1098 Fall River Ave.
Seekonk, MA 02771
508-336-8307
info@monacomodifieds.com
monacomodifieds.com
REGION: CT, MA, NH, VT
TYPE: Asphalt Modified Racing

MUST SEE RACING SPRINT SERIES

11255 Glen Hill Ln.
Holly, MI 48442
248-762-1732
hmsinc98@aol.com
msrxtreme.com
REGION: USA
TYPE: Pavement Winged Sprints

**NATIONAL ASSOCIATION FOR STOCK CAR
AUTO RACING (NASCAR)**

One Daytona Blvd.
Daytona Beach, FL 32114
800-630-0535
nascar.com
REGION: USA, Canada, Mexico, Europe
TYPE: Stock Car Racing

NATIONAL ASSOCIATION OF DIESEL MOTORSPORTS (NADM)

919 NE 101st Terr.
Kansas City, MO 64155
816-810-6287
ronk@dieselmotorsports.us
dieselmotorsports.us
REGION: USA

TYPE: Diesel Motorsports: Sted Pulling, Drag Racing, Dyno Competition, 4x4

NATIONAL AUTO SPORT ASSOCIATION (NASA)

7065 W. Ann Rd. #130-432
Las Vegas, NV 89130
510-232-6272
help@drivenasa.support
nasaproring.com
REGION: USA

TYPE: HPDE, NASA-X, Time Trial, Rally Sport, Road Racing

NATIONAL CHAMPIONSHIP RACING ASSOCIATION

444 N. Oliver #C1
Kechi, KS 67067
316-364-3093
mylisa44@gmail.com
racencra.com
REGION: KS

TYPE: 360 Sprints, Late Models

NATIONAL ELECTRIC DRAG RACING ASSOCIATION (NEDRA)

207 Indian Warrior Trl.
Lake Jackson, TX 77566
979-665-5621
info@nedra.com
nedra.com

REGION: USA, Canada, Europe, Australia, New Zealand

TYPE: Electric Vehicle Drag Racing

NATIONAL HOT ROD ASSOCIATION (NHRA)

104 Via Verde, Ste. 100
San Dimas, CA 91773
626-914-4761
nhra@nhra.com
nhra.com
REGION: USA

TYPE: Championship Drag Racing

NATIONAL JET RACING ASSOCIATION

2495 Palm Bay Rd.
Palm Bay, FL 32905
863-521-8634
elaine@lmsjets.com
njracing.com
REGION: CA
TYPE: Jet Drag Racing

NATIONAL TRACTOR PULLERS ASSOCIATION (NTPA)

6155-B Huntley Rd.
Columbus, OH 43229-1061
614-436-1761
info@ntpapull.com
ntpapull.com
REGION: USA

TYPE: Truck & Tractor Pulling

NITROCROSS

Thrill One Sports & Entertainment
946 W. 17th St.
Costa Mesa, CA 92627
info@thrillone.com
nitrocrossracing.com
REGION: USA & Canada
TYPE: Rallycross

NMCA MUSCLE CAR NATIONALS

3518 W. Lake Center Dr., Ste. D
Santa Ana, CA 92704
714-444-2426
office@promediapub.com
nmcadigital.com
REGION: USA
TYPE: Drag Racing

NMRA FORD NATIONALS

3518 W. Lake Center Dr., Ste. D
Santa Ana, CA 92704
714-444-2426
office@promediapub.com
nmradigital.com
REGION: USA
TYPE: Drag Racing

NORTH STATE MODIFIED SERIES

6131 E. Hwy. 20
Lucerne, CA 95458
707-274-1662
28arpy@mchsi.com
northstatemodifieds.com
REGION: CA
TYPE: Modified Racing

DESIGNED FOR DRAG RACING

CF90/10 FRONT SHOCKS



Engineered for vehicles with mid-range power, our CF Series is built to allow the front end of your car to come up easily with a better weight transfer and softest rate of rebound. Dual compression valving: high speed valving keeps your front end from bottoming out on hard landings and low speed compression allows the front to settle at the top end. Every recommended application has been closely evaluated for best length to ensure enough travel for maximum traction unlike stock shocks designed for street driving. STREET DRIVING NOT RECOMMENDED.

ASK A TECH:
661-728-9600
Hours: M-F 8am-4:30pm PST
CalvertRacing.com

Customer vehicle shown: Roland Wray's 1976 Chevrolet Lum California. Calvert Slicks, CF Front Racing Shocks, CR Rear Shocks, Calvert Spill Mono Leafsprings. Photo by: Daniel Vempis Photography

Work Hard. Play Harder.
CALVERT RACING



PRODUCTS:

- Circle Track Filters,
- Kart Racing Filters,
- Offroad Filters,
- Sprint Car Filters,
- Street/Muscle Car Filters,
- UTV/ATV Filters,
- Custom Filters and More



Contact:
Jon Maddocks OTR Filters
1-800-263-8660 605 Tower Road
jon@otrfilters.com Mundelein, IL 60060

www.otrfilters.com
(new website coming soon...)

**Tired of
Running
Hot?**

**Call Today!
1-800-842-5166**



RonDavis
RACING PRODUCTS
High Performance Radiators

All Types of Racing
Lightweight Aluminium Construction
Pressure Tested at 30 PSI
Furnace Brazed Cores
100% Tig Welded
6061-T6 Outlets
Glendale, Arizona

 RonDavisRadiators.com

SECTION **6** RACE SANCTIONING ORGANIZATIONS

NORTHEASTERN MIDGET ASSOCIATION (NEMA)

149 Brookview Ave.
Fairfield, CT 06825
917-435-8522
secretary@nemaracing.com
nemaracing.com
REGION: Northeast US
TYPE: Midget Racing

NORTHERN AUTO RACING CLUB (NARC)

4299 O'Connor Way
Sacramento, CA 95838
714-397-7417
info@narc410.com
narc410.com
REGION: CA
TYPE: Winged 410 Sprint Car Races

NORTHERN LATE MODEL RACING ASSOCIATION (NLRA)

2147 17th St. NE
Grand Forks, ND 58203
701-740-5201
nlracing@gmail.com
nlra.org
REGION: MN, ND, SD
TYPE: Dirt Late Model Racing

NOSTALGIA DRAG RACING LEAGUE (NDRL)

480 Town Center Dr. N. #260
Mooresville, IN 46158
314-517-4455
nostalgia dragleague.com
REGION: USA
TYPE: Pro 7.0, Pro 7.50, Pro Comp and Pro Gas

NOSTALGIA SUPER STOCK

US 36 Raceway
Osborn, MO 64474
262-844-2111
rberlisk@wi.rr.com
nostalgiasuperstock.com
REGION: USA
TYPE: Drag Racing Super Stock Cars of the 1960s

OIL CAPITAL RACING SERIES

412 E. 6th St.
Caney, KS 67333
620-330-0485
terry@ascsracing.com
ocsracing.net
REGION: KS, MO, OK, TX
TYPE: Sprint Car Racing

OUTLAW DIESEL SUPER SERIES

4960 N. 13th St.
Terre Haute, IN 47805
812-241-8541
info@outlawdieselss.com
outlawdieselss.com
REGION: USA
TYPE: Diesel Drag Racing, Diesel Pulling

OUTLAW STREET CAR ASSOCIATION

8071 Tillman Bethel Rd.
Henderson, KY 42420
270-452-9085
oscaseries@gmail.com
outlawstreetcars.com
REGION: KY
TYPE: Drag Racing

OUTLAW TRUCK & TRACTOR PULLING ASSOCIATION

745 Riverview Dr.
Rock Valley, IA 51247
712-470-1593
contact@outlawpulling.com
outlawpulling.com
REGION: USA
TYPE: Outlaw Truck and Tractor Pulling

OZARK MOUNTAIN SUPER SHIFTERS

118 Hollis St.
Kewanee, IL 61443
309-853-2626
jlclabough91@gmail.com
ozarkmountainsupershifters.com
REGION: Midwest
TYPE: Drag Racing

PORSCHE CLUB OF AMERICA

PO Box 6400
Columbia, MD 21045
410-381-0911
admin@pca.org
pca.org
REGION: USA, Canada
TYPE: Car Club

PORSCHE OWNERS CLUB

1968 S. Coast Hwy., #4911
Laguna Beach, CA 92651
619-630-0673
marketing@porscheclub.com
porscheclub.com
REGION: CA
TYPE: Car Club

PRI MEMBER BENEFITS

INDIVIDUAL MEMBERS

20%

**DISCOUNT ONLINE AT
GOODYEAR.COM**



JOIN TODAY!

VISIT:
PERFORMANCERACING.COM/MEMBERSHIP



POWRI RACING

8939 Bevo Ct.
Belleville, IL 62223
314-267-4944
kbrown@powri.com

powri.com

REGION: USA

TYPE: Open Wheel, National Midgets, Micros, Sprints

PREMIER STREET CAR ASSOCIATION (PSCA)

45423 6th St.
Lancaster, CA 93535
661-917-3078
mel@racesca.com

racesca.com

REGION: CO

TYPE: Heads-up, Index & Bracket Racing, Vegas Show Series, Vendors Midway

PRO ALL STARS SERIES (PASS)

195 Lakehouse Rd.
Naples, ME 04055
207-693-6497
passracing@roadrunner.com

proallstarsseries.com

REGION: CT, MA, ME, NH, VT

TYPE: National Super Late Models, North Super Late Models, New England Supermodified Series, and PASS Modifieds

PROFESSIONAL DRAG RACERS ASSOCIATION (PDRA)

111 Juliad Ct., Ste. 103
Fredericksburg, VA 22406
731-345-9058

tyler@pdra660.com

pdra660.com

REGION: MD, MI, NC, OH, SC, VA

TYPE: Drag Racing

PROTOTYPE SPRINT SERIES ASSOCIATION (PSSA)

1312 Regency Ct.
Southlake, TX 76092
888-965-7872

prototypesprint.com

REGION: CA, CT, GA, NV, NY, OR, TX, VA, WI

TYPE: Prototype Race Cars in a Sprint Format

QUARTER MIDGETS OF AMERICA (QMA)

31444 54th Ave. S.
Auburn, WA 98001
206-683-4041
president@quartermidgets.org

quartermidgets.org

REGION: USA, Canada

TYPE: Midget Racing

RACESAVER SPRINT SERIES

18561 Chicago Ct., Apt. 202
Elkhorn, NE 68022
402-238-2595
racesaver@yahoo.com

racesaver.com

REGION: USA

TYPE: Sprint Cars

RUSH RACING SERIES

4368 US 422
Pulaski, PA 16143
724-964-9300
info@rushracingseries.com

rushracingseries.com

REGION: DE, MD, NY, PA, VA, WV

TYPE: Dirt Late Models, Sprint Cars, Stock Cars, Modifieds, and Karts

SCCA PRO RACING

6620 SE Dwight St.
Topeka, KS 66619
sccaproracing.com

REGION: USA

TYPE: F4 US Championship, Formula Race Promotions, Formula Regional Americas, SCCA SRF3 Pro Racing, Trans Am Series

SCORE INTERNATIONAL

9434 Bond Ave.
El Cajon, CA 92021
775-852-8907
registration@score-international.com

score-international.com

REGION: USA & Mexico

TYPE: Off-Road Racing, Desert Racing

SOUTHERN ALL STAR DIRT RACING SERIES

132 Jetplex Ln.
Madison, AL 35758
256-924-4546
matt.wagner@sasdirt.com

sasdirt.com

REGION: AL, FL, GA, KY, NC, SC, TN, VA, WV

TYPE: Dirt Late Model

Racing. Towing. Hauling. Working.

CalTracs

for TRUCKS



<< Three Hole Pivot Plates shown

Low Pro, Drag Profile 3 and 4 Hole Lifted and Monster kits available.

Not just for racing, CALTRACS for TRUCKS hooks hard, stops wheel spin and wheel hop during hard acceleration in the dirt, going up hills, towing, hauling, and drag racing. CalTracs maintains pinion angle and prevents axle wrap that can damage suspensions.

Bolt on kit: no mods most applications
Easy Pre-load adjustability
Durable powder coated finish
Detailed Illustrated Installation Guide

ASK A TECH:
661-728-9600
Hours: M-F 8am-4:30pm PST
CalvertRacing.com

Customer vehicle shown: Payton's 2016 Chevrolet 2500 CalTracs

Work Hard. Play Harder.
CALVERT RACING

MADE IN THE USA



Development · Race · Production · Restoration



ABRADABLE POWDER COATINGS™

3 LOCATIONS SAME GREAT SERVICE!

LINE2LINE (HQ)
4866 White Lake Rd.
Clarkston, MI 48346
(248) 625-3052

LINE2LINE SOUTHEAST
580 Prison Camp Rd.
Campello, SC 29322
(864) 473-0637

LINE2LINE WEST
1406 #4 Industrial Way
Gardnerville, NV 89410
(775) 782-4060

Improve new parts 

Restore used parts 

WWW.LINE2LINECOATINGS.COM

PRI MEMBER BENEFITS

INDIVIDUAL MEMBERS GET
15%
DISCOUNT OFF NEXT PURCHASE



JOIN TODAY!

VISIT:
PERFORMANCERACING.COM/MEMBERSHIP



AMERICA'S FINEST COMPETITION CARBURETION
CARBURETORS FOR CHAMPIONS

Dirt Track Oval Track
Drag Race Road Course
Off Road Marine

- More Top End Power
- Broader Power-Band
- Smoother Acceleration

MORE THAN COMPLETE CARBURETORS

Premium Parts - Engine Building Programs - Rebuild Kits

(520) 579-9177

SALES@BRASWELL.COM

WWW.BRASWELL.COM



MOTOROLA SOLUTIONS

NO MORE STATIC!!!

Complete Digital System
ONLY \$899

Extra Crew
ONLY \$399

SameDay Shipping with
Phone and Live Video
Tech/Sales Support



www.sampsonracing.com / 866.396.7231

SECTION 6

RACE SANCTIONING ORGANIZATIONS

SOUTHERN CALIFORNIA TIMING ASSOC & BONNEVILLE NATIONALS

PO Box 10
Orosi, CA 93647
559-528-6279
office@scta-bni.org
scta-bni.org
REGION: CA, UT
TYPE: Land Speed Racing

SOUTHERN NEVADA OFF ROAD ENTHUSIASTS (SNORE)

4780 W. Ann Rd., Ste. 5452
North Las Vegas, NV 89031
702-736-6355
info@snoreracing.net
snoreracing.net
REGION: NV
TYPE: Off Road

SOVREN

17806 Bass Lane NW
Lakebay, WA 98349
360-329-2513
sovrenracing.org
REGION: Pacific Northwest
TYPE: Vintage Racing

SPEARS (SRL) SOUTHWEST TOUR SERIES

PO Box 6217
Bakersfield, CA 93386
661-679-4681
lcollins@mesamarin.com
srlsouthwesttour.com
REGION: Southwest
TYPE: Pavement Late Model Racing;
Pavement Modified Racing

SPEED ENERGY STADIUM SUPER TRUCKS

10615 Twin Lakes Pkwy.
Charlotte, NC 28269
704-949-1255
info@stadiumsupertrucks.com
stadiumsupertrucks.com
REGION: USA
TYPE: Off-road Truck Racing

SPORT COMPACT DIRT RACING ASSOCIATION

6 Birch St.
Woodruff, SC 29388
864-871-1442
kelcarms@gmail.com
scdra.net
REGION: AL, GA, KY, NC, SC, TN, VA
TYPE: Sport Compact Dirt Racing

SPORTS CAR CHAMPIONSHIP CANADA (SCCC)

23 Hannover Dr., Ste. 2
St. Catharines, ON L2W 1A3
Canada
905-704-8585
cb@feldrives.com
felmotorsports.com
REGION: Canada
TYPE: Road Racing

SPORTS CAR CLUB OF AMERICA

6620 SE Dwight St.
Topeka, KS 66619
800-770-2055
membership@scca.com
scca.com
REGION: USA
TYPE: Road Racing, Auto Cross

SPORTSCAR VINTAGE RACING ASSOCIATION (SVRA)

5487 E. Lake Rd.
Romulus, NY 14541
888-965-7872
kathy@svra.com
svra.com
REGION: USA
TYPE: Vintage Sports Car Racing

SRO MOTORSPORTS GROUP AMERICA

PO Box 633
Arlington, NE 68002
531-444-8558
susan.dunklau@sro-motorsports.com
sro-motorsports.com
REGION: USA
TYPE: Road Racing

STARS CHAMPIONSHIP SERIES

PO Box 2166
Noblesville, IN 46061
317-774-7021
info@starschampionshipseries.com
starschampionshipseries.com
REGION: IN, NC, OH, PA
TYPE: Karting

STOCK CAR RACE SERIES

PO Box 4432
Paso Robles, CA 93447
805-227-4409
info@stockcarraceseries.com
stockcarraceseries.com
REGION: CA
TYPE: Vintage Stock Car Racing

SUMMIT RACING MIDWEST DRAGS

PO Box 155
Westfield, IN 46074
317-299-7223
heid@midwestdrags.com
summitmidwestdrags.com
REGION: MD, NJ, VA
TYPE: Drag-N-Drive

SUNOCO AMERICAN LATE MODEL SERIES

PO Box 411
Grayville, IL 62844
618-450-2072
sdriggers@dirtrcar.com
americanlatemodelseries.com
REGION: IL, IN, MI
TYPE: Late Model Racing

SUPER DIRT CAR SERIES

7575-D West Winds Blvd.
Concord, NC 28027
704-795-7223
info@dirtrcar.com
superdirtrcarseries.com
REGION: FL, NC, NJ, NY, OH, & Canada
TYPE: Big Block Modified Racing

SUPERKARTS! USA (SKUSA)

33175 Temecula Pkwy., Ste. 233
Temecula, CA 92592
951-491-0808
info@superkartsusa.com
superkartsusa.com
REGION: USA, Canada
TYPE: Shifter Kart Racing

TEXAS DIRT TRUCK SERIES

210-449-4506
texasdirtruckseries@gmail.com
texasdirtrucks.com
REGION: TX
TYPE: Dirt Truck Racing

TEZOS ALL STAR CIRCUIT OF CHAMPIONS (ASCOC)

438 Southpoint Cir.
Brownsburg, IN 46112
800-867-6067
allstars@tonystewart.com
allstarsprint.com
REGION: FL, GA, MI, MO, NY, OH, PA, WI
TYPE: Winged Sprint Car Racing

CLEAR VIEW FILTRATION
SEE THROUGH OIL FILTER ASSEMBLY
THESE FILTERS ALLOW VISUAL INSPECTION OF FILTERED PARTICLES IN SECONDS, WITHOUT LOSING OR LEAKING ANY OIL, UNBOLTING ANY FASTENERS OR FITTINGS WE OFFER A VARIETY OF FILTERS FOR WET OR DRY SUMP SYSTEMS OFFERED IN CLEAR OR BLACK ANODIZED

BILLET DRY SUMP TANK WITH THE SEE THROUGH FILTER ON TOP, TANKS HAVE NO WELDS & ARE COMPLETELY MACHINED CLEAR OR BLACK ANODIZED

2023 PRI BOOTH 514

DEVELOPING THE FUTURE OF OIL FILTRATION

WWW.CLEARVIEWFILTRATION.COM 509-467-7584

CAN USE FILTERS WITH DISPOSABLE FILTERS ON THE BOTTOM FOR DUAL FILTRATION!!

LS SBC BBC 409 SBF HEMI WEDGE

HARDCORE PERFORMANCE

All BMP Blocks are made from 357T6 Aluminum & have billet steel caps, ARP Studs, replaceable Ductile Iron Sleeves & accept OEM Accessories. Our goal to supply nothing but the best at affordable prices.

Check Out Our Huge Selection Of High Performance Parts at **BILLMITCHELLPRODUCTS.COM**

386.957.3009

BMP HARD CORE RACING
BILL MITCHELL PRODUCTS

100% Made in the U.S.A.

BDS SUPERCHARGERS

BDS Blowers 100% NEW

Street Strip Show

All sizes & Stages in stock

Huge Manifold Selection

Ford
Buick
Pontiac
Cadillac
LS-L57
Chrysler
Chevrolet
Oldsmobile

Phone: 562-693-4302 **blowerdriveservice.com**



IDIDIT[®]
PERFORMANCE
Lightweight Steering Columns and Accessories

Quick Release Steering Hubs

Quick Release Steering Hubs

Pro-Lite Steering Column

Pro-Fab Steering Column

Quick Release Steering Hubs

- American Made
- SFI Certified
- Available in 3, 5, or 6 bolt designs
- Quick and easy install using factory dash mounts
- Machined with extremely tight tolerances that eliminate backlash for tight steering and feel
- Center pin design ensures a perfect wheel centering every time

Lightweight Steering Columns

- American Made
- Engineered for superior fit, finish, and performance
- Save up to 20 pounds of weight
- Quick and easy install using factory dash mounts
- Pro-Lite Series can go from street to strip featuring turn signals, 4-way flashers, and wiring plug
- Pro-Fab Series includes components to retain original column shroud keeping the stock appearance

IDIDIT LLC., 610 S. Maumee Street, Tecumseh, MI | 517-424-0577 | ididit.com



LS
SBC
BBC
409
SBF
HEMI
WEDGE

LESS WEIGHT = PERFORMANCE

All BMP Blocks are made from 357T6 Aluminum & have billet steel caps, ARP Studs, replaceable Ductile Iron Sleeves & accept OEM Accessories. Our goal to supply nothing but the best at affordable prices.

Check Out Our Huge Selection Of High Performance Parts at BILLMITCHELLPRODUCTS.COM

386.957.3009

BMP HARD CORE RACING
BILL MITCHELL PRODUCTS

DRIVESHAFT SHOP X GRINGOTEGRA

MYLES KERR - ENGLISH RACING
THE WORLDS FASTEST AWD INTEGRA
216MPH 1/2 MILE
7.71 BEST 1/4 MILE ET
195MPH BEST 1/4 MILE

BOOTH: 4251

PRI
PERFORMANCE RACING INDUSTRY

PRECISION TURBO

WORLD LEADER IN DRIVESHAFT SALES & DRIVESHAFTS

TOP GUN SPRINT SERIES

6333 Burts Rd.
Tampa, FL 33619
813-677-7326
annrehm43@gmail.com
topgunsprints.com
REGION: FL
TYPE: Winged Dirt Sprint Car Racing

ULTRA4 RACING

35820 Galena Cir.
Temecula, CA 92592
844-590-1234
info@ultra4racing.com
ultra4racing.com
REGION: USA, Mexico, Europe
TYPE: Off Road and King of the Hammers

UNITED MANUAL TRANSMISSION RACERS NORTH

216-402-8901
umtr.north1@gmail.com
umtrnorth.com
REGION: OH
TYPE: Stick-shift Drag Racing

UNITED MANUAL TRANSMISSION RACERS SOUTH

1339 St. Rt. 50
Milford, OH 45150
513-748-4586
umtrsouth@gmail.com
umtrdragrace.com
REGION: KY, OH
TYPE: Stick-shift Drag Racing

UNITED REBEL SPRINT SERIES

PO Box 389
Drumright, OK 74030
918-417-0624
terry@ascsracing.com
urssracing.com
REGION: KS, NE, OK
TYPE: Sprint Series

UNITED SPRINT CAR SERIES

175 Antebellum Way
Fayetteville, GA 30215
770-865-6097
peteuscs@att.net
uscsracing.com
REGION: AL, AR, FL, GA, MS, NC, SC, TN
TYPE: Sprint Car Racing

UNITED STATES ASSOCIATION OF PULLERS

2974 Tibbs Rd.
 Brownsville, TN 38012
 731-445-2492
 cynthia@usapullers.org
 usapullers.org
REGION: AL, AR, KY, MO, MS, TN
TYPE: Truck and Tractor Pulling

UNITED STATES AUTO CLUB (USAC)

4910 W. 16th St.
 Speedway, IN 46224
 317-247-5151
 richie@usacracing.com
 usacracing.com

REGION: USA

TYPE: Silver Crown, Sprint Car, Midget, Ignite, 25 Next Gen, Off-Road, Rally

UNITED STATES MODIFIED TOURING SERIES

PO Box 905
 Webster City, IA 50595-0905
 515-832-7944
 media@usmts.com
 usmts.com
REGION: USA
TYPE: Dirt Modified

UNITED STATES RACING ASSOCIATION

PO Box 905
 Webster City, IA 50595-0905
 515-832-6000
 media@usracing.com
 usracing.com
REGION: USA
TYPE: Modified Stock Cars, Late Model, Sprint Cars, B-Mods, Hobby

UNITED STATES SPEED ASSOCIATION

750 E. 900 S.
 Pendleton, IN 46064
 317-938-5726
 info@ussaracing.com
 ussaracing.com
REGION: IN, MI, OH
TYPE: Kenyon Midget Races

UNITED STATES TOURING CAR CHAMPIONSHIP (USTCC)

PO Box 2008
 Napa, CA 94558
 707-643-1000
 ali@ustcc.com
 ustcc.com
REGION: CA, NJ, NV, NY, OR, PA, WV
TYPE: Road Racing

DO IT RIGHT... RACE WITH THE LEGEND!
75TH ANNIVERSARY TRIBUTE T BUILT BY DENNIS TAYLOR

NEW RODZILLA CAM LINE
ISKENDERIAN CAMS
 + HUNDREDS OF NEW CAM GRINDS FOR LS, LIT APPLICATIONS

SHOP ONLINE 24/7 - TRY OUR EASY MAKE AND MODEL SEARCH!
WWW.ISKYCAMS.COM 310.217.9232

ISKY RACING CAMS
 @ISKYRACINGCAMS
 /ISKYRACINGCAMS

Billet Threaded Caps

www.JAZProducts.com
800-525-8133 CALL FOR FREE CATALOG!

CHAMP PANS

QUALITY RACING PRODUCTS by JR Mfg.

We offer over 1,000 high performance products used in Racing, Street, Off-Road and Marine for Chevrolet, Chrysler and Ford applications.

715-834-7748 Visit Our Website www.champpans.com Email Us: jrmfg@champpans.com



**A BETTER BURN
MEANS BETTER
PERFORMANCE**

PRI BOOTH 3905

E3 Ignition Products

NHRA

NASCAR COMPETITION PARTNER

UPPER MIDWEST SPRINT CAR SERIES

2700 420th St. W.
Harris, MN 55032
612-363-5302
ron@umsprints.com
umsprints.com
REGION: IA, MN, WI
TYPE: Sprint Car Racing

US LEGEND CARS INTERNATIONAL

5245 Hwy. 49 S.
Harrisburg, NC 28075-8476
704-455-3896
gechapman@uslegendcars.com
uslegendcars.com
REGION: USA
TYPE: Legends, Bandoleros

**USF PRO 2000 CHAMPIONSHIP
PRESENTED BY COOPER TIRES**

10101 US Hwy. 41 N.
Palmetto, FL 34221
941-845-2500
info@usfproracing.com
usf2000.com
REGION: United States and Canada
TYPE: Open Wheel Racing Series

**VINTAGE AUTO RACING
ASSOCIATION (VARA)**

4195 Chino Hills Pkwy., #457
Chino Hills, CA 91709
800-280-8272
vara@msn.com
vararacing.com
REGION: AZ, CA
TYPE: Pre-war Historics, All Vintage Race Cars Up To 1989

WILROC SPRINT CAR RACING

Canada
250-812-7195
wilrocracing.com
REGION: Canada
TYPE: Sprint Cars

WISSOTA Promoters Association

2700 1st St. N., Ste. 209
Saint Cloud, MN 56303
320-251-1360
wissota.org
REGION: ID, MN, MT, ND, SD, WI, WY, & Canada
TYPE: Late Model, Modified, Super Stock, Midwest Mod, Street Stock, Pure Stocks, Hornets, Mod Four



1 800 TOP RODS

DYER'S TOP RODS

Put the best in your LS!

PRI SHOW BOOTH 1904

WWW.DYERSRODS.COM



Engine Ice

ICE WATER RACING COOLANT

NOTHING COOLS BETTER.

Superior heat transfer over antifreeze
Corrosion & oxidation protection
Glycol Free

10X BETTER
10X BETTER

Learn more at www.engineice.com

Engine Ice



KEEP UP WITH PRI

PRI SHOW BOOTH 1904

PRISHOW.COM/SOCIAL

PRI PERFORMANCE RACING INDUSTRY

WORLD DRAG RACING ALLIANCE (WDRA)

PO Box 20440
Springfield, IL 62708
567-224-0568
racewdra.com
REGION: USA & Canada
TYPE: Drag Racing

WORLD EXTREME ROCK CRAWLING

51 N Broadway, #142
Blackfoot, ID 83221
530-417-5333
werocklive.com
REGION: USA
TYPE: Off-road, Event Promoter

WORLD KARTING ASSOCIATION

560 Pitts School Rd. NW, Ut. G
Concord, NC 28027
704-455-1606
worldkarting.com
REGION: USA
TYPE: Kart Racing

WORLD RACING GROUP

7575-D Westwinds Blvd.
Concord, NC 28027
704-795-7223
worldracinggroup.com
REGION: USA
TYPE: DIRTcar Racing, World of Outlaws, Xtreme Outlaw Series

WORLD RACING LEAGUE

4134 Jersey Pike
Chattanooga, TN 37421
423-321-2111
racewrl.com
REGION: USA
TYPE: Road Racing

WSK PROMOTION SRL

Plaza della Repubblica, 8
73024 Maglie, Lecce, Italy
+39-0836-427550
info@wskarting.com
wskarting.it
REGION: International
TYPE: Kart Racing

SEE US
IN INDY!
Booth #2925

RACE WITH GEARSTAR

Custom built transmissions and converters
dyno tested 100 miles!

LEVEL 5 4L85E SUPERMATIC
SUPPORTS 2,000 HP AND FT-LBS!



23 YEARS
OF PERFORMANCE

GEARSTAR
PERFORMANCE TRANSMISSIONS

YONK Performance
CONVERTERS

GEARSTAR.com 330-434-5216 CONVERTER.cc

PRI MAGAZINE COVERS THE BUSINESS OF RACING

27,000 PRINT • 95,000+ DIGITAL DISTRIBUTION

ADVERTISE TODAY!

VISIT PERFORMANCERACING.COM



THE BUSINESS OF RACING STARTS HERE!

PRI
PERFORMANCE RACING INDUSTRY



SECTION

7

MANUFACTURERS' REPRESENTATIVES

An invaluable link between suppliers and the customers who move their products, manufacturers' representatives interact with everyone from the largest warehouse distributors to the smallest speed shops and engine builders. They typically act as a supplier's outside sales force. Many also work trade shows and/or car shows for their clients, while others manage their customers' wholesale operations.

LOVE RACING? *JOIN THE CLUB!*



**IT'S TIME TO
BECOME A MEMBER!**

*WITH MULTIPLE MEMBERSHIP OPTIONS,
WE HAVE THE PERFECT ONE FOR YOU!*



SCAN QR CODE
FOR MORE
INFORMATION

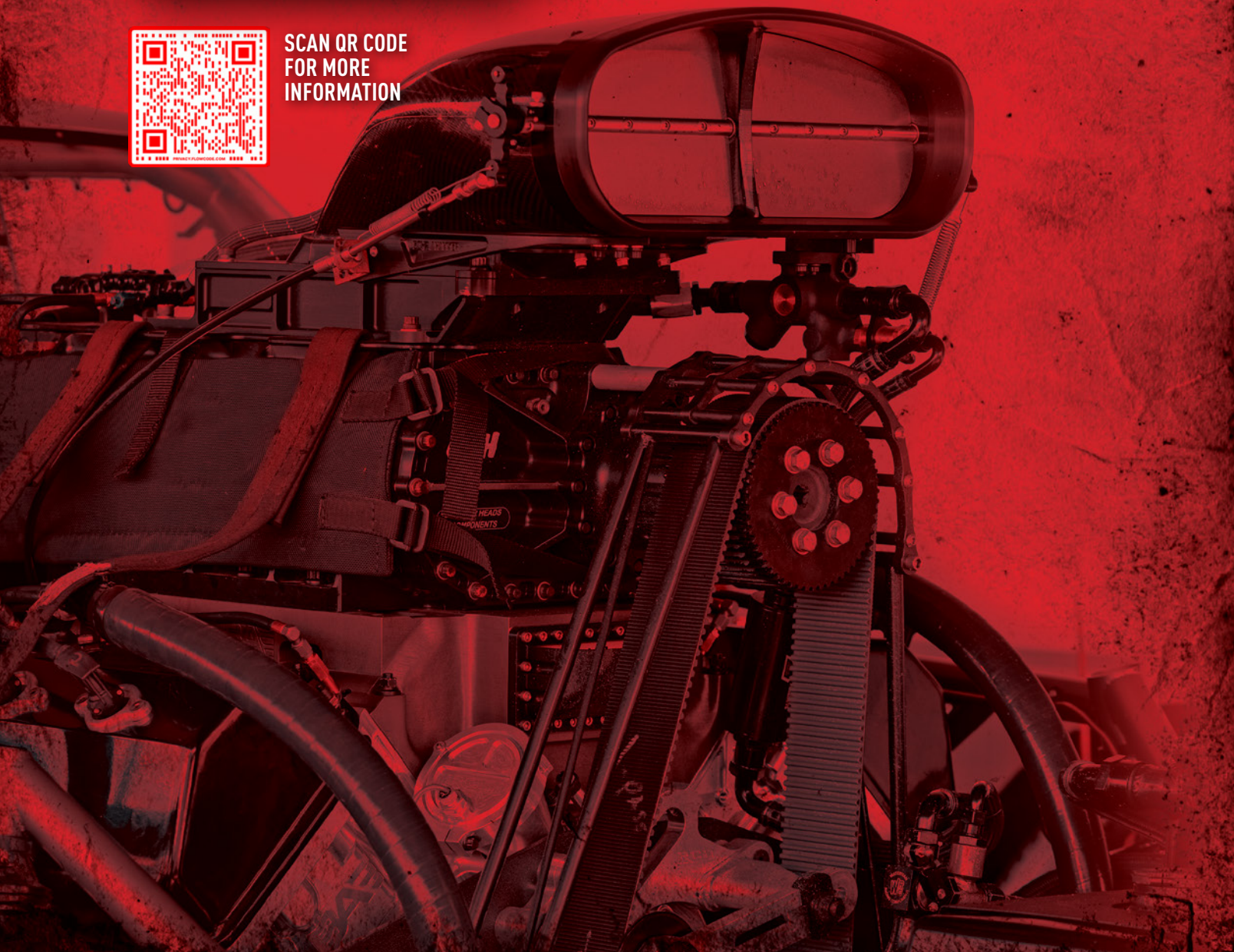



MOTIVE COMPONENTS LTD
The Engine Experts Since 1981.

BRITISH QUALITY SINCE 1981

TecAlliance
Data Supplier

BRITISH PERFORMANCE PARTS



DEC 7-9th GREEN HALL BOOTH: 1235

Concept → Design → Finished Product

- Timing Chain Kits
- Valve Train
- Bearings
- Camshafts
- Cylinder Heads
- Gaskets
- Piston Rings
- Oil Pumps
- Much more...

+44 (0) 1908 368 995
sales@motivecomponents.co.uk
www.motivecomponents.co.uk

10K SALES & MARKETING

623 Nightingale Blvd.
Stillwater, MN 55082
651-238-5788

TERRITORY: MN, ND, SD, WI
LINES: Howard Industries, HR Performance, ITM, Midwest Acorn Nut, Valco Cincinnati

AIRHEART SALES

13805 409th Ave. SE
North Bend, WA 98045
425-888-2540

airheartsales.com

TERRITORY: AK, AZ, CA, CO, HI, ID, MT, NM, NV, OR, UT, TX, WA, WY, & Canada

LINES: ACL, Be Cool, Cometic, Howard's, Klotz Racing Oil, Magnecor, Prothane, Race Winning Brands, Schumann's Oil Pumps, ThermoTec, Total Seal

ALL-MIDWEST SALES

Jim Morehouse
2111 Lanterman Circle
Hinckley, OH 44233
216-225-4564
allmidwestsales.com

TERRITORY: AL, AR, CO, FL, GA, IA, IL, IN, KS, KY, LA, MI, MN, MO, MS, NC, ND, OH, OK, SC, SD, TN, TX, VA, WI, WV

AMERICAN SALES & MARKETING

Sid Bower
825 College Blvd., Ste. 102-315
Oceanside, CA 92057
760-726-8226
asmwp.com

TERRITORY: USA: Account Specific/Military Exchange System

LINES: Firestone, Horizon Tire, The Hoffman Group, K Tool International/Ford Tools, K1 Race Gear, Kafko International, Kookaburra Liquorice, Kyowa Racing Wheels, NTP Stag, Pentius Filters, Phoenix Systems, Razor USA, Rightline Gear, SATCO Products, Shurhold Industries, Tonkin Parts Center, Torin Inc., Van Leeuwen Distributing, WeatherTech, World and Main (HBC Home & Hardware), XS Power Batteries

APPLIED COMPONENTS

33410 Liberty Pkwy.
North Ridgeville, OH 44035
440-458-4638
aci-sales.com

TERRITORY: East Coast & ON, Canada

Protection with Endurance.



Paint •
Lights •
Rollcage •

LAMIN-X
PROTECTIVE FILMS

lamin-x.com

**CECOMP® F20B Series
8 Memory Pressure Gauges**

Made in USA

±0.25%
or ±0.1%
Accuracy

Tires - Shocks - Compression - Vacuum
cecomp.com 800-942-0315

RADIAL BEARING CORPORATION

www.radialbearing.com
sales@radialbearing.com

**PROVEN IN THE AIR...
PROVEN ON THE TRACK...**

- Aircraft Quality ROD END and SPHERICAL BEARINGS
- Self Lubricating (PTFE) and Metal-to-Metal
- Alloy and Stainless Steels
- Specials for Specific Engineering Needs

AS9100 / ISO 9001

1-800-377-1937 for a free catalog
Fax: (203) 744-1691

LINES: AL Hansen, BEI Duncan, Crouzet, Delphi Diesel Systems, Hamsar Diversco, Jet Fabricators, Kavlico, MTE Hydraulics, Nason Company, OEM Fabricators, Voisard Manufacturing, R&R Engineering, VDO (Continental)

AUTOMOTIVE AFTERMARKET REPS

516-794-7770
TERRITORY: USA

AUTOREP SALES CO.

Walt Siklich
 725 S. Adams Rd., Ste. L-145
 Birmingham, MI 48009
 248-792-5442
 autorepsales.com
TERRITORY: IL, IN, KY, MI, OH, Western PA, WI, WV

BALLARD & ALLEN MARKETING

Jessica Chance
 PO Box 9020
 Kalispell, MT 59904
 949-722-7716
 ballardallen.com
TERRITORY: West of the Mississippi and West Canada

BC SALES & MARKETING

91 Marlyn Dr.
 Newark, OH 43055-9509
 740-366-2872
TERRITORY: IN, KY, MI, OH
LINES: Flaming River Industries, Power Stop, Ratech

BOB COOK SALES

9245 Poplar Ave., Ste. 5 #129
 Germantown, TN 38138
 901-854-4632
 bobcooksales.com
TERRITORY: USA

CHRIS KOURI & ASSOCIATES

1200 N. Jefferson St., Ut. K
 Anaheim, CA 92807
 714-630-2311
 chriskouri.com
TERRITORY: AK, AZ, CA, HI, ID, NV, OR, WA

CONSIDINE SALES & MARKETING

Jim Considine
 611 S. Milford Rd.
 Highland, MI 48357
 248-889-7887

considinesales.com
TERRITORY: IA, IL, IN, KS, KY, MI, MN, MO, ND, NE, OH, Western PA, SD, WI, WV
LINES: Competition Engineering, Daystar, Dee Zee, Fluidampr, Hushmat, Hypertech Inc., McGard Inc., Moroso Performance Products, Northern Radiator, Professional Products, Racing Automotive Group, Remflex, Seals-It, Stage 8 Fasteners, Timbren Industries, Weathertech Automotive

DEVEREAUX JONES COMPANY

1355 Canadaville Loop
 Eads, TN 38028
 901-317-6937
 devjones@djonesco.com
TERRITORY: USA
LINES: Brakes, Chemicals, HP Starters & Alternators, Internal Engines, Relays

DON GROSS SALES

1951 E. 48th St.
 Vernon, CA 90058
 323-582-3450
 dongross.com
TERRITORY: Southern California; Baja California; Las Vegas, NV; AZ
LINES: Durabond, Melling, Safety Auto, SB International, Silver Seal, UEM Pistons, US Tool

EPJ ASSOCIATES

PO Box 399
 Glenside, PA 19038-0399
 215-619-0773
 epj-inc.com
TERRITORY: USA
LINES: American Cylinder Head (USA), CCCN (USA), CVR (Northeast), QUALCAST (Northeast)

FOSTER BABCOCK & ASSOCIATES

313 Delaware St.
 Kansas City, MO 64105
 816-283-3355
 fosterbabcock.com
TERRITORY: IA, IL, KS, MN, MO, ND, NE, SD, WI
LINES: Anzo USA, Bed Slide, Chemical Guys, Cometic Gasket, COMP Cams, Du-Ha, Edelbrock, End of the Road, Everest, Fan Mats, FedPro, Flex-A-Lite, Flezilla, GelPro, Hamaton, Horizon Global, Horizon Tool, K Source, K&N, Legacy, Legend Brands, McGard, Mile Marker, Race Winning Brands, Reese, Russell, SKP, Southern Truck, Spectre Performance, Tera Pump, Ultratech Polymers, UltraScent, Un-Duz-It, VDP, WOLO

COMETIC
 GASKET

ph: (440) 354-0777 · 1 (800) 752-9850
 www.cometic.com

f t i in

IWAY

IWAY-TECH.COM
 812-254-6456
 C.N.C. Ported Heads & Manifolds
 Race Engine Development

World Leader In Temperature Sensors!

EXHAUST GAS **Motorsports**
EGT Engine Dyno
 TECHNOLOGIES, INC. Industrial
 Aerospace

MADE IN THE USA
 WITH PRIDE

1-800-348-4678
 Sales@exhaustgas.com

ROBINS SINCE 1958
 Signature brand

RUBi-hard
 Premium 3-Angle Inserts
 3 angle inserts for hardened valve seats

Get min 50% more life compared to any other 3-angle inserts

Independent Sales Reps required

Carbide Pilots (Live / fixed)

f t i in /robinsmachines | rc@RobinsMachines.com
 www.RobinsMachines.com



www.VACmotorsports.com

@VACMOTORSPORTS

+1 (215) 462-4666 sales@vacmotorsports.com



- Friction Resistant Calico Coatings
- Eliminate OEM Bearing Failure
- B48 | B58 | S14 | S38 | M50 | M52 | M54 | N52 | N54 | N63 | S50 | S52 | S54 | S55 | S63 | S85 + More Applications



VAC RTI SUPER DAMPER Crank Dampers

- Isolate Damaging Harmonic Vibrations
- Allow Engines to Produce More Horsepower
- B58 | S14 | M50 | M52 | M54 | N52 | N54 | S50 | S50B30 | S50B32 | S52 | S54 | S55 Applications



VAC Billet Differential Covers

- Available for E36, E46 M3, E9x, Z4 / Supra
- Increased Oil Capacity and Cooling
- Improved Strength over Factory Cast Cover



VAC Billet Engine Blocks

- High Strength 6061-T6 Aluminium Block
- Extreme Weight Savings over Factory Iron Block
- Can Stand 1500+ Horse Power
- S14 | S38 | M50 | M52 | S50 | S52 | S54 Applications

See More:



SECTION 7 MANUFACTURERS' REPRESENTATIVES

HARRY MILLER SALES

162 Doug Allison Heights
Cleveland, GA 30528
706-809-9145
harrymillersales.com

TERRITORY: USA

LINES: ATM Innovation, Cometic Gasket, King Engine Bearings, Klotz Synthetic Lubricants, Larsen Racing, Pimp Juice, TI Automotive/Walbro, Valco Cincinnati CP

JAMISON EQUIPMENT

John or Stew
1908 11th St.
Emmetsburg, IA 50536
800-841-5405
jamisonequipment.com

TERRITORY: USA

LINES: ABS Products, AXE Equipment, BHJ Products, Hines Industries, Saenz Performance USA, Turner Technology

JIM KERR & ASSOCIATES

45 Carriage House Dr.
Holland, PA 18966-2224
215-355-3613
jimkerr.com

TERRITORY: DE, MD, NJ, NY, PA, VA (Fairfax County)

LINES: Busch, Moroso, Made 4 You, McGard, Royal Purple

JIM WROBLESKI & CO

2146 N. Karwick Rd., Ste. A
Michigan City, IN 46360-7381
219-879-8145
jwcreps.com

TERRITORY: IL, IN, KY, MI, MN, ND, OH, PA, SD WI, WV

KAM MARKETING

411 Old Baltimore Pike, Ste. 101
Chadds Ford, PA 19317
302-658-7778
kammarketing.com

TERRITORY: CT, DE, IL, IN, KY, MA, MD, ME, MI, NC, NJ, NY, OH, PA, RI, TN, VA, VT, WI, WV, Eastern Canada

LINES: Eaton, Energy Suspension, KW Automotive, Magnaflow, Milodon, Northern Factory Radiator, Permatex, Powermaster

KUNZMAN & ASSOCIATES

4094 Pioneer Dr.
Walled Lake, MI 48390-1351
248-360-2700
kunzman.com

ICRP
864.580.1858
OWNER OF THE CV PRODUCTS BRAND
CV RACING PRODUCTS
sales@cvracingproducts.com

IMPROVE YOUR STEERING
AVAILABLE IN 4 RATIOS

GEN5
SMALL BOX



Stiletto
STEERING SYSTEMS

231-873-9252
pro-werks.com/stiletto

POINT ONE
HIGH PERFORMANCE FASTENERS

- MADE IN AMERICA
- VERTICALLY INTEGRATED MANUFACTURING IN-HOUSE
- MANUFACTURED TO THE MOST PRECISE STANDARDS FOR HIGH PERFORMANCE MARKETS
- SUPERIOR CUSTOMER SERVICE WITH FAST DELIVERY

P1MFG.COM
417.753.5174

PRISHOW BOOTH 1936

TERRITORY: USA and Western Canada
LINES: AeroQuip, ARP, Bestop, Fitech, Hedman Heddgers, QA1, Scat, Westin

MACK EQUIPMENT SALES

4224 Lassek Ct.
Eau Claire, WI 54703
715-579-8423
mackequipmentsales.com
TERRITORY: IA, IL, MN, ND, NE, SD, WI, Upper Peninsula of MI
LINES: Axe Equipment, LS Industries, Rottler

MC SALES & MARKETING

15581 Computer Ln.
Huntington Beach, CA 92649
714-901-8589
mcsalesmarketing.com
TERRITORY: AZ, CA, CO, NM, NV, UT

OWEN EQUIPMENT SALES

84 Andrea Dr.
Richboro, PA 18954-1302
215-322-7344
TERRITORY: DE, MD, NJ, PA
LINES: Delta Custom Tools, Irontite by Kwik-Way, RMC Engine Rebuilding Equipment, Silver Seal Products Co., Sunnen Products Company

PROREP MARKETING

14 Meade Ln.
Enfield, CT 06082
860-698-6022
aolson@prorepmarketing.com
prorepmarketing.com
TERRITORY: DC, DE, MD, NJ, NY, PA, New England & Canada
LINES: Aeromotive, ARP, AutoMeter, EGR, Flex-A-Lite Consolidated, Motive Gear, Painless Performance Products

R & R MARKETING CONSULTANTS

PO Box 481383
Kansas City, MO 64148
650-588-3404
rrmci.com
TERRITORY: USA
LINES: Aeromotive, Canton Racing Products, COMP Cams, Derive Systems (SCT, Bully Dog, Derive Efficiency), Driven Racing Oil, Edelbrock, Energy Suspension, Evans Cooling Systems, Grant Products, Hastings Manufacturing Company, King Engine Bearings, Lunati, MAHLE Motorsports, Painless Performance Products, Revtek Industries, TCI Automotive, US Gear, ZEX

PATENTED CERAMIC LUBRICANT

TESTED #1 FOR EXTREME PRESSURE & FILM STRENGTH

TriboDyn® Lubricants

ENGINEERED TO:

- ✓ Perform Under Extreme Pressure & Heat
- ✓ Enhance Motor Performance & Horsepower
- ✓ Form a Ceramic Film Under Extreme Conditions
- ✓ Improve Fuel Mileage
- ✓ Reduce Operating Temperature
- ✓ Reduces Wear & Increases Engine Life



TriboDyn Lubricants
P. O. Box 117, Mooresville, NC 28115
+1-704-266-3577 | info@TriboDyn.com

www.TriboDyn.com
MADE IN THE USA

TriboDyn
LUBRICANTS

PENSKE RACING SHOCKS

3 SHOCK SETUP SUPPORT

DESIGNED TO WIN

- @penskeshocks
- @penske_racing_shocks
- @penskeracingshocks

WWW.PENSKESHOCKS.COM
610-375-6180

BOOTH #1625

VR IOP

VALVE REFACING MACHINE

Diamond & CBN Grinding wheels offering Long Life & Less frequent wheel dressing.

• Large coolant and filtration
Cool and Clean Grinding

Foot pedal for ball chuck locking and unlocking

Machines displayed may include optional accessories

[/robinsmachines](https://www.facebook.com/robinsmachines) | rc@RobinsMachines.com
www.RobinsMachines.com

ROGUE SERIES TURBO COVER

KEEPS THE TURBINE SPOOLED UP
REDUCES UNDER-HOOD TEMPERATURES

COOL IT.
Thermo Tec

MADE IN USA

Enter code **PRI20** to receive 20% off your order at ThermoTec.com

(800) 274-8437 www.ThermoTec.com

Available at:



Visit us at PRI Booth 1836

PRI MEMBER BENEFITS

INDIVIDUAL
MEMBERS GET

10%

DISCOUNT
AT SPEEDIAGNOSTIX.COM

SPEEDiagnostix

How To Know You're Good To Go.

JOIN TODAY!

VISIT:
PERFORMANCERACING.COM/MEMBERSHIP



PRI
PERFORMANCE RACING INDUSTRY

CONNECT



PRISHOW.COM/SOCIAL

SECTION 7

MANUFACTURERS' REPRESENTATIVES

REPFORCE

210 Turner Industrial Way
Aston, PA 19014

610-485-7800

repforce.com

TERRITORY: USA and Canada

LINES: Accel Performance/Mr. Gasket,
Airaid, Bosch Service Solutions, Derale, FIA,
Hedman, Pioneer Performance, Vision X

REPWORKS MARKETING

3707 E. Southern Ave.

Mesa, AZ 85206

602-279-1987

repworksmktg.com

TERRITORY: AK, AZ, CA, HI, NM, NV, OR, WA

LINES: Bosch Gauges, Surco

RT SALES

1625 N. Milford Rd.

Highland, MI 48357-3807

248-887-0422

rtsalesinc.com

TERRITORY: USA

LINES: Serdi Corporation, Sunnen Products
Company

SCOTT LEWIS ASSOCIATES

994 Northern Blvd.

Baldwin, NY 11510

516-378-6100

scottlewisinc.com

TERRITORY: AL, AR, AZ, CA, CO, CT, DC,
DE, FL, GA, IA, ID, IL, KS, KY, LA, MA, MD,
ME, MI, MN, MO, MS, MT, NC, ND, NE, NH,
NJ, NM, NV, NY, OH, OK, OR, PA, PR, RI, SC,
TN, TX, UT, VA, WI, WV & Eastern Canada,
Western Canada

LINES: Berryman, Cometic Gaskets, CP
Pistons, Daido Engine Bearings, Davies
Craig, Exedy, G3, Global Parts, Go Light,
Howards Cams, Meyer Plows, Milemarker,
Neapco, Redarc, Rollmaster, Romac,
Speedflow, Turbosmart, Westcan

SHERMAN PEARSON COMPANY

26309 Miles Rd., Ste. 5

Cleveland, OH 44128-5997

216-464-3094

shermanpearson.com

TERRITORY: IL, IN, KY, MI, NY, OH, PA, WI, WV

THE KAYES CO

Pat Sheffer

643 Bear Run Ln.

Lewis Center, OH 43035-7133

614-481-8811

thekayesco.com

TERRITORY: USA

LINES: Heartthrob Exhaust

THE SHOP DOC

Lyle Haley

15550 Linnet St. NW, Apt. 301

Andover, MN 55304

763-464-1286

TERRITORY: USA

LINES: Consulting for engine rebuilders,
shop layout, workflow, work processes, and
equipment purchasing

THOMAS SALES AND MARKETING

317-846-7024

ron.thomasco@sbcglobal.net

thomassalesco.com

UHLE & CLARK

1452 Turkey Trot Rd.

Warwick, PA 18974

215-588-0067

uhleclark.com

TERRITORY: USA

LINES: Dura-Bond Bearing Co., Inc., Lucas
Oil Products, Melling Performance

WILLIAM GARNER & ASSOCIATES

12720 S. 38th St.

Bellevue, NE 68123-2803

402-292-9369

TERRITORY: IA, KS, MN, MO, NE, ND, SD, WI

LINES: COMP Cams, Milodon, TCI Automotive

WOODWARD EQUIPMENT

15790 SE Piazza Ave., Ste. 104

Clackamas, OR 97015-9141

503-657-6680

woodwardequipment.com

TERRITORY: USA

LINES: AXE Equipment, BHI Products,
Delta Custom Tools, Hines Industries,
Irontite by Kwik-Way, Neway Manufacturing,
Silver Seal Products Co., Van Norman, Zero
Error Racing



SECTION

8

WAREHOUSE DISTRIBUTORS

These operations bridge the gap between motorsports industry suppliers and the retail businesses that deal directly with racers and team members. Among their myriad functions, warehouse distributors (WDs) provide valuable storage space, communication tools, technical support, cataloging, and other useful services. Several also work within an established marketplace, giving them unique insight into the parts and equipment in demand for a specific region.

ALLPRO DISTRIBUTING

43 Airpark
Alabaster, AL 35007
800-858-4487
customer@allprodistributing.net
allprodistributing.net

ATECH MOTORSPORTS

1200 Southeast Ave.
Tallmadge, OH 44278
800-517-1040
customerservice@atechmotorsports.com
atechmotorsports.com

BEHRENT'S PERFORMANCE WAREHOUSE

38 Meadow Rd.
Florida, NY 10921
845-651-7389
behrents.com

BOLTSANDNUTS.COM

3705 Lane Rd. Ext.
Perry, OH 44081
440-606-6557
info@boltsandnuts.com
boltsandnuts.com

COMPETITION PRODUCTS

280 W. 35th Ave.
Oshkosh, WI 54902
800-233-0199
info@competitionproducts.com
competitionproducts.com

DAY MOTOR SPORTS

6100 US Hwy. 69 N.
Tyler, TX 75706
800-543-6238
daymotorsports.com

ENGINE AND PERFORMANCE WAREHOUSE

955 Decatur St., Ut. D
Denver, CO 80204
303-572-8844
epwi.net

ENGINE PRO

198 Industrial Park Rd.
Piney Flats, TN 37686
423-282-0211
enginepro.com

JEGS HIGH PERFORMANCE

101 Jeg's Pl.
Delaware, OH 43015
800-345-4545
jegs.com

JOBBERS WAREHOUSE SUPPLY

800 Third Ave. N.
Minneapolis, MN 55405-1606
800-489-4520
612-377-4520
info@enginepartspro.com
enginepartspro.com

JOHNSTON RESEARCH & PERFORMANCE

2344 S. Sheridan Way
Mississauga, ON L5J 2M4
Canada
905-822-7223
jrponline.com

KEYSTONE AUTOMOTIVE OPERATIONS

44 Tunkhannock Ave.
Exeter, PA 18643
800-521-9999
customer@keystone.com
keystoneautomotive.com

MEYER DISTRIBUTING

560 E. 25th St.
Jasper, IN 47546
800-MEYER-USA
meyerdistributing.com

MOSS MOTORS LTD.

440 Rutherford St.
Goleta, CA 93117
800-667-7872
805-681-3400
moss.sales@mossmotors.com
mossmotors.com

MOTOR STATE DISTRIBUTING

8300 Lane Dr.
Watervliet, MI 49098
800-772-2678
269-463-4113
info@motorstate.com
motorstate.com

NATIONAL PERFORMANCE WAREHOUSE

11150 NW 32nd Ave.
Miami, FL 33167
800-344-0368
npwcompanies.com
Entry on Page 64

NICKELS PERFORMANCE

293 Industrial Park Rd.
Piney Flats, TN 37686
800-251-0331
nickels-performance.com

PLATINUM RACING PRODUCTS

2/11 Reliance Dr.
Tuggerah, New South Wales
Australia 2259
+61 449 688 530
platinumracingproducts.com

**PREMIER PERFORMANCE
PRODUCTS DISTRIBUTION**

7976 Rubicon Trail Pl. NW
Silverdale, WA 98383
888-497-3666
premierwd.com

SCOGGIN DICKEY PARTS CENTER

5901 Spur 327
Lubbock, TX 79424
800-456-0211
sdparts.com

SPEED AND ENGINE WAREHOUSE

2001 E. 19th St.
Tucson, AZ 85719
800-365-4292
520-792-1830
speedandengine.com

SPEEDWAY MOTORS

340 Victory Ln.
Lincoln, NE 68528
855-313-9181
speedwaymotors.com

TORQUED DISTRIBUTION

121 S. Maple Ave., Ste. 4
South San Francisco, CA 94080
415-767-6905
help@torqueddistribution.com
torqueddistribution.com

TURN 14 DISTRIBUTION

100 Tournament Dr.
Horsham, PA 19044
877-7TURN14
267-468-0350
turn14.com

XTREME DIESEL PERFORMANCE

1758 State Route 34 N.
Wall Township, NJ 07727
888-DIESEL-4
732-719-0955
xtremediesel.com

ABS Products

591 W. Apollo St.
Brea, CA 92821
714-671-0728
abs-products.com
Category: MACHINERY, TOOLS & EQUIPMENT
Entry on Page 145

ACC Performance Products Plus

2817 E. Avalon Ave.
Muscle Shoals, AL 35661
256-381-1965
accperformance.com
Category: CHASSIS, DRIVELINE & SUSPENSION COMPONENTS
Entry on Page 86

Advanced Fuel Dynamics

12843 Vaughan Rd.
Troy, TX 37830
866-902-3835
advancedfueldynamics.com
Category: ENGINE COMPONENTS
Entry on Page 52

Advanced Racing Suspensions

1698 Midwest Blvd.
Indianapolis, IN 46214
317-271-7100
advancedracing.net
Category: CHASSIS, DRIVELINE & SUSPENSION COMPONENTS
Entry on Page 86

Advantage Lifts

387 Larcom St.
Thousand Oaks, CA 91360
805-795-3778
donb@advantagelifts.com
advantagelifts.com
Category: MACHINERY, TOOLS & EQUIPMENT
Entry on Page 145

AFCO Racing

340 Victory Ln.
Lincoln, NE 68528
800-632-2320
afcoracing.com
Category: CHASSIS, DRIVELINE & SUSPENSION COMPONENTS
Entry on Page 74

Air Flow Research

28611 Industry Dr.
Valencia, CA 91355
661-257-8124
sale@airflowresearch.com
airflowresearch.com
Category: ENGINE COMPONENTS
Entry on Page 52

Aldan American

2675 Temple Ave.
Signal Hill, CA 90755
310-834-7478
aldanamerican.com
Category: CHASSIS, DRIVELINE & SUSPENSION COMPONENTS
Entry on Page 86

Anderson Composites

1215 Bixby Dr.
City of Industry, CA 91745
626-333-7024
sales@andersoncomposites.com
andersoncomposites.com
Category: CHASSIS, DRIVELINE & SUSPENSION COMPONENTS
Entries on Pages 75 & 76

ApexTurbo USA

1706 Covell Rd.
Dundee, MI 48131
734-777-1380
apexturbo.com
Category: ENGINE COMPONENTS
Entry on Page 52

ARE Dry Sump Systems

2890 Lopes Ln.
Loomis, CA 95650
916-652-5282
info@drysump.com
drysump.com
Category: ENGINE COMPONENTS
Entry on Page 10

Arias Pistons

1902 McGaw Ave.
Irvine, CA 92614
310-532-9737
arias Pistons.com
Category: ENGINE COMPONENTS
Entry on Page 53

ARP

1863 Eastman Ave.
Ventura CA 93003
800-826-3045
info@arpfasteners.com
arp-bolts.com
Category: ENGINE COMPONENTS
Entry on Page 14

Ashcroft

250 E. Main St.
Stratford, CT
203-378-8281
techinfo@ashcroft.com
ashcroft.com
Category: RACING COMPONENTS, ACCESSORIES & SERVICES
Entry on page 98

ATI Performance Products

6718 Whitestone Rd.
Baltimore, MD 21207
410-298-4343
atiracing.com
Category: ENGINE COMPONENTS
Entry on Page 53

ATL Racing Fuel Cells

45 Spear Rd.
Ramsey, NJ 07446
201-825-1400
atl@atlinc.com
atfuelcells.com
Category: CHASSIS, DRIVELINE & SUSPENSION COMPONENTS
Entry on Page 87

ATM Innovation

141 Vanderbilt Ct.
Bowling Green, KY 42103
270-846-3964
atminnovation.com
Category: ENGINE COMPONENTS
Entry on Page 53

Automatic Transmission Design

W140N10145 Cond Du Lac Ave.
Germantown, WI 53022
262-251-7777
autotransdesign.com
Category: CHASSIS, DRIVELINE & SUSPENSION COMPONENTS
Entry on Page 77

AutoRod Corporation

21 Le Valley Dr.
Englishtown, NJ 07726
732-851-5095
autorod.net
Category: RACING COMPONENTS, ACCESSORIES & SERVICES
Entry on Page 99

Aviaid Oil Systems

10041 Canoga Ave.
Chatsworth, CA 91311
818-998-8991
aviaidhp@gmail.com
aviaid.com
Category: ENGINE COMPONENTS
Entry on Page 54

AWA Forged Composites

46-E Peninsula Center Dr., Ste. 251
Rolling Hills Estates, CA 90274
310-308-0024
awacomposites.com
Category: ENGINE COMPONENTS
Entry on Page 54

BAT Inc./Mocal USA

7630 Matoaka Rd.
Sarasota, FL 34243
941-355-0005
sales@batinc.net
batinc.net
Category: ENGINE COMPONENTS
Entry on Page 54

Behrent's Performance Warehouse

38 Meadow Rd.
Florida, NY 10921
845-651-7389
behrents.com
Category: ENGINE COMPONENTS
Entry on Page 55

Bill Mitchell Products

1726 Hibiscus Dr.
Edgewater, FL 32132
386-957-3009
billmitchellproducts.com
Category: ENGINE COMPONENTS
Entry on Page 55

Billet Connection/ClearView Filtration

7320 N. Regal St.
Spokane, WA 99217
509-467-7584
mike@billetconnection.com
billetconnection.com
Category: ENGINE COMPONENTS
Entry on Page 55

Blower Drive Service

1511 N. Kraemer Blvd.
Anaheim, CA 92806
714-632-5678
blowerdriveservice.com
Category: ENGINE COMPONENTS
Entry on Page 56

BluePrint Engines

2915 Marshall Ave.
Kearney, NE 68847
800-483-4263
blueprintengines.com
Category: ENGINE COMPONENTS
Entry on Page 56

BOELLINGER GROUP Holding GmbH

Salinenstrasse 38-44
74177 Bad Friedrichshall
Germany
470-636-2923
boellinger-group.com
Category: ENGINE COMPONENTS
Entry on Page 56

BR Motorsports Ignitioneering

2216 E. Mineral King Ave.
Visalia, CA 93292
559-739-1515
blake@brmotorsports.com
brpromag.com
Category: ENGINE COMPONENTS
Entry on Page 16

Brodix

PO Box 1347
Mena, AR 71953
479-394-1075
talktous@brodix.com
brodix.com
Category: ENGINE COMPONENTS
Entry on Page 57

SUPPLIERS INDEX

Bully Dog

4150 Church St., Ste. 1024
Sanford, FL 32771
407-774-2447
marketing@derivesystems.com
bullydog.com
Category: RACING COMPONENTS, ACCESSORIES & SERVICES
Entry on Page 117

C&S Specialties

3528 Hwy. B
St. Charles, MO 63301
636-723-4996
info@candsspecialties.com
candsspecialties.com
Category: ENGINE COMPONENTS
Entry on Page 57

Calvert Racing

4530 Runway Dr.
Lancaster, CA 93536
661-728-9600
calverttracing.com
Category: CHASSIS, DRIVELINE & SUSPENSION COMPONENTS
Entry on Page 78

Champ Pans

6198 US Hwy. 12
Eau Claire, WI 54701
715-834-7748
champpans.com
Category: ENGINE COMPONENTS
Entry on Page 57

Chassis Engineering

1500 Ave. R, Ste. 300
Riviera Beach, FL 33404
561-863-2188
chassisengineering.com
Category: CHASSIS, DRIVELINE & SUSPENSION COMPONENTS
Entry on Page 87

CHE Precision

2586 Calcite Cir.
Newbury Park, CA 91320
805-499-8885
cheprecision.com
Category: ENGINE COMPONENTS
Entry on Page 58

Cheyenne Reed Racing

1835 N. Entertline Rd.
Punxsutawney, PA 15767
510-990-0099
acceloracewear.com
Category: RACING COMPONENTS, ACCESSORIES & SERVICES
Entry on Page 117

Chicane Racing

250 Valley High Dr.
Bozeman, MT 59718
406-570-5886
john@chicaneracing.com
chicaneracing.com
Category: RACING COMPONENTS, ACCESSORIES & SERVICES
Entry on Page 117

Circle D Specialties

5003 Langfield Rd.
Houston, TX 77040
713-589-8664
circledspecialties.com
Category: CHASSIS, DRIVELINE & SUSPENSION COMPONENTS
Entry on Page 87

Clay Smith Cams

5870 Dale St.
Buena Park, CA 90621
800-454-7999
claysmithcams.com
Category: MACHINERY, TOOLS & EQUIPMENT
Entry on Page 145

Coker Tire

1317 Chestnut St.
Chattanooga, TN 37402
800-959-4500
support@coker.com
cokertire.com
Category: CHASSIS, DRIVELINE & SUSPENSION COMPONENTS
Entry on Page 79

Comec

7807 Addison Rd.
Masury, OH 44438
800-887-6076
comecus.com
Category: MACHINERY, TOOLS & EQUIPMENT
Entry on Page 136

Computech Systems

29971 Business Center Dr.
Charlotte Hall, MD 20622
301-884-5712
computech.com
Category: RACING COMPONENTS, ACCESSORIES & SERVICES
Entry on Page 118

Cool Boss

30440 Agoura Rd.
Agoura Hills, CA 91301
855-223-2665
coolboss.com
Category: MACHINERY, TOOLS & EQUIPMENT
Entry on Page 137

CoolDrive Auto Parts

22-28 Lexton Rd.
Box Hill, Victoria, 3128
Australia
0400178755
simon.richards@cooldrive.com.au
lshop.cooldrive.com.au/
Category: ENGINE COMPONENTS
Entry on Page 58

CP-Carrillo

1902 McGaw Ave.
Irvine, CA 92614
949-290-0189
sales@cp-carrillo.com
cp-carrillo.com
Category: ENGINE COMPONENTS
Entry on Page 18

CRP Cantrell Racing Products

728 Sandy Ford Rd.
Chesnee, SC 29323
864-580-1858
crracingproducts.com
Category: ENGINE COMPONENTS
Entry on Page 58

CTech Manufacturing

7501 Commerce Dr.
Weston, WI 54776
715-355-8842
hello@ctechmanufacturing.com
ctechmanufacturing.com
Category: MACHINERY, TOOLS & EQUIPMENT
Entry on Page 138

CTEK

5521 N. Cumberland Ave.
Chicago, IL 60656
330-283-7879
smartercharger.com
Category: MACHINERY, TOOLS & EQUIPMENT
Entry on Page 145

Cutting Edge Automotive Solutions

22703 Racine St.
Robertsdale, AL 36567
855-839-2626
ceasusa.com
Category: MACHINERY, TOOLS & EQUIPMENT
Entry on Page 146

Davis Technologies

5 Perrion Ave.
Asheville, NC 28787
828-645-1505
moretraction.com
Category: RACING COMPONENTS, ACCESSORIES & SERVICES
Entry on Page 118

Dayco

16000 Common Rd.
Roseville, MI 48066
800-848-7902
na.daycoaftermarket.com
Category: ENGINE COMPONENTS
Entry on Page 20

DayStar Machine & Cycle Concepts

1003 S. Main St.
Dobson, NC 27017
336-984-7784
daystarmcc.com
Category: CHASSIS, DRIVELINE & SUSPENSION COMPONENTS
Entry on Page 88

Dayton Lamina Corporation

500 Progress Rd.
Dayton, OH 45449
937-384-3626
daytonlamina.com
Category: RACING COMPONENTS, ACCESSORIES & SERVICES
Entry on Page 118

DCM Manufacturing

4540 W. 160th St.
Cleveland, OH 44135
440-666-5507
maradynhp.com
Category: ENGINE COMPONENTS
Entry on Page 59

DeatschWerks

415 E. Hill St.
Oklahoma City, OK 73105
405-217-0701
deatschwerks.com
Category: ENGINE COMPONENTS
Entry on Page 59

DELTA PAG

1444 30th Rd.
Astoria, NY 11102
212-203-2912
deltapag.com
Category: ENGINE COMPONENTS
Entry on Page 22

Design Engineering, Inc.

604 Moore Rd.
Avon Lake, Ohio 44012
440-930-7940
sales@designengineering.com
designengineering.com
Category: RACING COMPONENTS, ACCESSORIES & SERVICES
Entry on Page 100

Digital Racing Cards

5122 Haltata Ct.
New Port Richey, FL 34655
727-247-5597
racefacedigital.com
Category: RACING COMPONENTS, ACCESSORIES & SERVICES
Entry on Page 119

DRC Race Products

10986 Route 235
Beaver Springs, PA 17812
570-658-3515
drcraceproducts.com
Category: MACHINERY, TOOLS & EQUIPMENT
Entry on Page 146

Driveline Studios

511 Old Towne Rd., #81633
Rochester, MI 48308
813-625-4495
drivelinestudios.com
Category: RACING COMPONENTS, ACCESSORIES & SERVICES
Entry on Page 119

DriveShaft Shop

4530 Southmark Dr.
Salisbury, NC 28147
800-564-2244
driveshaftshop.com
Category: CHASSIS, DRIVELINE & SUSPENSION COMPONENTS
Entry on Page 88

DRP Performance Products

5784 Virginia Ave.
Bassett, VA 24055
540-483-4442
codyb@drpperformance.com
drpperformance.net
Category: CHASSIS, DRIVELINE & SUSPENSION COMPONENTS
Entry on Page 88

Eat Sleep Race

PO Box 7502
North Brunswick, NJ 08902
732-921-4547
eatsleeprace.com
Category: RACING COMPONENTS, ACCESSORIES & SERVICES
Entry on Page 101

Elgin Industries

1100 Jansen Farm Dr.
Elgin, IL 60123
800-323-6764
elginind.com
Category: ENGINE COMPONENTS
Entry on Page 59

Elite Tuned School

136 4th St. N., Ste. 201
St. Petersburg, FL 33701
727-741-2637
elitetunedschool.com
Category: RACING COMPONENTS, ACCESSORIES & SERVICES
Entry on Page 102

Engine Works

293 Industrial Park Rd.
Piney Flats, TN 37686
423-391-0032
rjohnson@nickelsperformance.com
engineworksproducts.com
Category: ENGINE COMPONENTS
Entry on Page 60

EQ Systems

19300 Grange St.
Cassopolis, MI 49031
800-846-9659
eqsystems.us
Category: RACING COMPONENTS, ACCESSORIES & SERVICES
Entry on Page 119

Exhaust Gas Technologies

15642 Dupont Ave., Ste. B
Chino, CA 91710
909-548-8100
exhaustgas.com
Category: MACHINERY, TOOLS & EQUIPMENT
Entry on Page 146

FASS Diesel Fuel Systems

16234 Hwy. 0
Marthasville, MO 63357
636-429-7008
fassride.com
Category: ENGINE COMPONENTS
Entry on Page 60

FedPro

4520 Richmond Rd.
Cleveland, OH 44128
216-464-6440
fpcintl.com
Category: MACHINERY, TOOLS & EQUIPMENT
Entry on Page 146

FiTech Fuel Injection

12370 Doherty St., Ste. A
Riverside, CA 92570
951-340-2624
fitechefi.com
Category: ENGINE COMPONENTS
Entry on Page 24

Five Star Race Car Bodies

PO Box 700
Twin Lakes, WI 53181
262-877-2171
fivestarbodies.com
Category: CHASSIS, DRIVELINE & SUSPENSION COMPONENTS
Entry on Page 89

Fleece Performance Engineering

2400 Commerce Way
Pittsboro, IN 46167
317-286-3573
fleeceperformance.com
Category: ENGINE COMPONENTS
Entry on Page 60

FOD Control Corporation

548 Forest Center Plaza
Garland, TX 75042
800-425-8363
fodcontrol.com
Category: RACE TRACK EQUIPMENT & SUPPLIES
Entry on Page 159

FTI Performance

1815 Patterson Ave.
DeLand, FL 32724
386-736-5816
ftiperformance.com
Category: CHASSIS, DRIVELINE & SUSPENSION COMPONENTS
Entry on Page 80

G-FORCE Racing Gear

4231 Southside Dr., Ste. 300
Acworth, GA 30101
770-998-8855
info@gforce.com
gforce.com
Category: RACING COMPONENTS, ACCESSORIES & SERVICES
Entry on Page 120

Gedore Tools

4055 Faber Place Dr., Ste. 214
North Charleston, SC 29405
843-270-3966
info@gedorettools.com
klann-online.de
Category: MACHINERY, TOOLS & EQUIPMENT
Entry on Page 147

Get'm Performance Products

1566 WG Talley Rd.
Alvaton, KY 42122
270-935-5334
info@getmperformance.com
getmperformance.com
Category: ENGINE COMPONENTS
Entry on Page 61

GForce Performance Engineering

7111 W. 151st St., Ste. 302
Overland Park, KS 66223
316-260-8433
gforce1320.com
Category: CHASSIS, DRIVELINE & SUSPENSION COMPONENTS
Entry on Page 89

Giant Finishing

600 Factory Rd.
Addison, IL 60101
708-343-6900
giantfinishing.com
Category: MACHINERY, TOOLS & EQUIPMENT
Entry on Page 139

Goodson Tools & Supplies

156 Galewski Dr.
Winona, MN 55987
507-452-1830
goodson.com
Category: MACHINERY, TOOLS & EQUIPMENT
Entry on Page 147

Green Filter USA

2152 University Dr., Rte. 119
Mt. Braddock, PA 15465
724-430-2050
greenfilterusa.com
Category: ENGINE COMPONENTS
Entry on Page 61

H-P Products

512 W. Gorgas St.
Louisville, OH 44641
330-875-5556
h-pproducts.com
Category: RACING COMPONENTS, ACCESSORIES & SERVICES
Entry on Page 103

Heritage-Crystal Clean

2000 Center Dr., Ste. East C300
Hoffmann Estates, IL 60192
877-938-7948
crystal-clean.com
Category: MACHINERY, TOOLS & EQUIPMENT
Entry on Page 148

HMS Motorsport

119 Bevan Dr.
Mooresville, NC 28115
978-774-1615
hmsmotorsport.com
Category: RACING COMPONENTS, ACCESSORIES & SERVICES
Entry on Page 120

Hoosier Racing Tire

65465 SR 931
Lakeville, IN 46536
574-784-3152
hoosiertire.com
Category: CHASSIS, DRIVELINE & SUSPENSION COMPONENTS
Entry on Page 89

Hot Shoe Racewear

289 Farm Rd.
Newville, PA 17241
717-701-1599
hotshoeracewear@gmail.com
hotshoeracewear.com
Category: RACING COMPONENTS, ACCESSORIES & SERVICES
Entry on Page 120

Hot Shot's Secret

3975 Morrow Meadows Drive
Mount Gilead, OH 43338
614-354-8833
hotshotsecret.com
Category: RACING COMPONENTS, ACCESSORIES & SERVICES
Entry on Page 121

Howards Cams

280 W. 35th St.
Oshkosh, WI 54902
920-230-4241
advertising@howardscams.com
howardscams.com
Category: ENGINE COMPONENTS
Entry on Page 26

Howe Racing Enterprises

3195 Lyle Rd.
Beaverton, MI 48612
989-435-7080
howeracing.com
Category: CHASSIS, DRIVELINE & SUSPENSION COMPONENTS
Entry on Page 90

HP Tuners

700 Eastwood Ln.
Buffalo Grove, IL 60089
224-900-0269
hptuners.com
Category: RACING COMPONENTS, ACCESSORIES & SERVICES
Entry on Page 121

Hushmat & Zycoat

15032 W. 117th St.
Olathe, KS 66062
913-599-2600
zycoat.com
Category: RACING COMPONENTS, ACCESSORIES & SERVICES
Entry on Page 121

Huth Ben Pearson International

260 Grant St.
Hartford, WI 53027
800-558-7808
huthbenders.com
Category: MACHINERY, TOOLS & EQUIPMENT
Entry on Page 148

Hylift Johnson

1185 E. Keating Ave.
Muskegon, MI 49442
773-487-1400
toplineauto.com
Category: ENGINE COMPONENTS
Entry on Page 61

IDIDIT

610 S. Maumee St.
Tecumseh, MI 49286
517-424-0577
ididit.com
Category: CHASSIS, DRIVELINE & SUSPENSION COMPONENTS
Entry on Page 90

Indy Race Parts

361 Gasoline Alley, Ste.A
Indianapolis, IN 46222
317-244-9437
indyraceparts.com
Category: RACING COMPONENTS, ACCESSORIES & SERVICES
Entry on Page 122

InEarz Sport

170 N. Cypress Way
Casselberry, FL 32707
407-339-2422
inearzsport.com
Category: RACING COMPONENTS, ACCESSORIES & SERVICES
Entry on Page 122

InTech Trailers

29286 Co. Rd. 52
Nappanee, IN 46550
574-773-9536
intech.com
Category: RACING COMPONENTS, ACCESSORIES & SERVICES
Entry on Page 122

ISSPRO

2515 NE Riverside
Portland, OR 97211
503-528-3400
isspro.com
Category: RACING COMPONENTS, ACCESSORIES & SERVICES
Entry on Page 123

JackPak

30440 Agoura Rd.
Agoura Hills, CA 91301
833-522-5725
jackpak.com
Category: MACHINERY, TOOLS & EQUIPMENT
Entry on Page 140

Jaz Products

1212 E. Santa Paula St.
Santa Paula, CA 93060
805-525-8800
info@jazproducts.com
jazproducts.com
Category: RACING COMPONENTS, ACCESSORIES & SERVICES
Entry on Page 123

Jesel

1985 Cedar Bridge Ave., Ste. 2
Lakewood, NJ 08701
732-901-1800
jesel.com
Category: ENGINE COMPONENTS
Entry on Page 62

JMS Performance Group

240 Springview Commerce Dr.
Debary, FL 32713
601-766-9424
jmschip.com
Category: ENGINE COMPONENTS
Entry on Page 28

Joie Of Seating

4537 Orphanage Rd.
Concord, NC 28027
704-795-7474
thejoieofseating.com
Category: RACING COMPONENTS, ACCESSORIES & SERVICES
Entry on Page 123

KD Kanopy

1921 E. 68th Ave.
Denver, CO 80029
303-650-1436
kdkanopy.com
Category: RACING COMPONENTS, ACCESSORIES & SERVICES
Entry on Page 124

Keizer Aluminum Wheels

1001 Industrial Ave.
Alton, IA 51003
712-737-3053
keizerwheels.com
Category: CHASSIS, DRIVELINE & SUSPENSION COMPONENTS
Entry on Page 90

King Racing Products

2216 East Mineral King Ave.
Visalia, CA 93292
559-636-1655
kingracingproducts.com
Category: CHASSIS, DRIVELINE & SUSPENSION COMPONENTS
Entry on Page 91

Kotwica Engineering

Concejal Hector Noya 1446
Lanus 1824 Buenos Aires
Argentina
+54 11 4249 9379
kotwica-engineering.com.ar
Category: ENGINE COMPONENTS
Entry on Page 62

Kowi Automotive

3348 Service St., Ste. G
Charlotte, NC 28206
980-938-4828
kowiatautomotive.com
Category: ENGINE COMPONENTS
Entry on Page 62

Larson Systems

13847 Aberdeen St. NE
Ham Lake, MN 55304
763-780-2131
larsonsystems.com
Category: MACHINERY, TOOLS & EQUIPMENT
Entry on Page 148

Late Model Engines

1930 Aldine Western Rd.
Houston, TX 77038
713-849-4505
collin@latemodelengines.com
latemodelengines.com
Category: ENGINE COMPONENTS
Entry on Page 63

Linde Gas & Equipment

7000 High Grove Blvd.
Burr Ridge, IL 60527
800-225-8247
lindedirect@linde.com
lindedirect.com
Category: MACHINERY, TOOLS & EQUIPMENT
Entry on Page 148

Longacre Racing Products

977 Hyrock Blvd.
Boonville, IN 47601
800-423-3110
longacreracing.com
Category: CHASSIS, DRIVELINE & SUSPENSION COMPONENTS
Entry on Page 81

LPC Electronics

119 Greenwich Ave.
Steubenville, OH 43952
949-491-3988
usalpc.com
Category: ENGINE COMPONENTS
Entry on Page 63

M&M Competition Engines

1421 Amy Ln., Ste. A
Franklin, IN 46131
317-739-3187
mmcompetitionengines.com
Category: ENGINE COMPONENTS
Entry on Page 63

MAHLE Aftermarket

23030 Mahle Dr.
Farmington Hills, MI 48335
248-347-9712
mahle-aftermarket.com
Category: ENGINE COMPONENTS
Entry on Page 64

Mastercam

671 Old Post Rd.
Tolland, CT 06084
860-875-5006
mastercam.com
Category: MACHINERY, TOOLS & EQUIPMENT
Entry on Page 149

Maxima Racing Oils

9263 Abraham Way
Santee, CA 92071
619-449-5000
maximausa.com
Category: RACING COMPONENTS, ACCESSORIES & SERVICES
Entry on Page 104

MaxJax

5240 Willis Rd.
Theodore, AL 36582
844-629-5291
maxjax.com
Category: MACHINERY, TOOLS & EQUIPMENT
Entry on Page 141

MAXX-D Trailers

7075 FM 38 N
Brookston, TX 75421
352-629-1562
maxxdtrailers.com
Category: RACING COMPONENTS, ACCESSORIES & SERVICES
Entry on Page 124

MB Metal Technologies

403 S. Hawley Rd.
Milwaukee, WI 53214
855-897-1439
mbmetaltech.com
Category: MACHINERY, TOOLS & EQUIPMENT
Entry on Page 149

McLeod Racing

1570 Lakeview Loop
Anaheim, CA 92807
714-630-2764
info@mcleodracing.com
mcleodracing.com
Category: CHASSIS, DRIVELINE & SUSPENSION COMPONENTS
Entry on Page 82

Mel Hamblton Racing

11771 W. Kellogg
Wichita, KS 67209
316-462-1430
racemh.com
Category: RACING COMPONENTS, ACCESSORIES, & SERVICES
Entry on Page 124

Melling Performance

2620 Saradan Dr.
Jackson, MI 49202
517-787-8172
dszymecko@melling.com
melling.com
Category: ENGINE COMPONENTS
Entries on Pages 30 & 32

Metalloid Corporation

1160 White St.
Sturgis, MI 49091
269-503-7300
f.edwards@metalloidcorp.com
metalloidcorp.com
Category: RACING COMPONENTS, ACCESSORIES & SERVICES
Entry on Page 105

Molnar Technologies

4101 40th St. SE, Ste. 2
Kentwood, MI 49512
616-940-4640
molnartechnologies.com
Category: ENGINE COMPONENTS
Entry on Page 34

Motec Systems USA

235 Raceway Dr.
Mooresville, NC 28117
704-799-3800
motec.com
Category: RACING COMPONENTS, ACCESSORIES & SERVICES
Entry on Page 125

Nitro Manufacturing

510 Performance Rd.
Mooresville, NC 28115
704-663-3155
nitromfg.com
Category: RACING COMPONENTS, ACCESSORIES & SERVICES
Entry on Page 125

Nitrous Express

5411 Seymour Hwy.
Wichita Falls, TX 76310
940-767-7694
nitrousexpress.com
Category: ENGINE COMPONENTS
Entry on Page 64

Northern Radiator

2701 4th Ave. SW
Willmar, MN 56201
800-328-8900
northernradiator.com
Category: ENGINE COMPONENTS
Entry on Page 65

Offroad Anonymous

18657 Honor Hwy.
Interlochen, MI 49643
231-383-5664
offroadanonymous.com
Category: CHASSIS, DRIVELINE & SUSPENSION COMPONENTS
Entry on Page 91

OptiTorque Technologies

1B Powell Ln.
Penn Yan, NY 14527
315-924-3888
sales@optitorque.com
optitorque.com
Category: ENGINE COMPONENTS
Entry on Page 36

Pacific Performance Engineering

3679 Civic Center Dr.
North Las Vegas, NV 89030
725-238-2002
mark.kirtner@ppepower.com
ppepower.com
Category: ENGINE COMPONENTS
Entry on Page 38

PennGrade 1

801 Edwards Dr.
Lebanon, IN 46052
317-923-5321
penngrade1.com
Category: RACING COMPONENTS, ACCESSORIES & SERVICES
Entry on Page 125

Performance Bearing

468 N. 1200 W.
Lindon, UT 84042
801-597-6950
Category: ENGINE COMPONENTS
Entry on Page 65

Performance CBN

3487 Dunn's Ridge
Kalamazoo, MI 49006
269-217-4262
performancecbn.com
Category: MACHINERY, TOOLS & EQUIPMENT
Entry on Page 150

Performance Design

2840 Auburn Ct.
Auburn Hills, MI 48326
248-507-4885
performancecdesign.com
Category: ENGINE COMPONENTS
Entry on Page 65

Performance Distributors

2699 Barris Dr.
Memphis, TN 38132
901-396-5782
performancedistributors.com
Category: ENGINE COMPONENTS
Entry on Page 66

Performance Eng & Mfg

425 Industrial Park Dr.
Saint Clair, MO 63077
636-629-6200
pemracing.com
Category: CHASSIS, DRIVELINE & SUSPENSION COMPONENTS
Entry on Page 91

Performance Plus Global Logistics

942 Hemsath Rd.
St. Charles, MO 63073
636-946-7587
info@pplplusglobal.com
pplplusglobal.com
Category: RACING COMPONENTS, ACCESSORIES & SERVICES
Entry on Page 106

Peterson Fluid Systems

14331 Hilltop Rd.
Longmont, CO 80504
800-926-7867
pfsinfo@specprod.com
petersonfluidsys.com
Category: ENGINE COMPONENTS
Entry on Page 39

Pit Pal Products

2009 Horizon Ct.
Zion, IL 60099
847-872-7257
pitpal.com
Category: MACHINERY, TOOLS & EQUIPMENT
Entry on Page 150

Pit-Pro Custom Carts

1756 W. County Rd. 300 S.
Greencastle, IN 46135
317-858-1830
pitprousa.com
Category: RACE TRACK EQUIPMENT & SUPPLIES
Entry on Page 159

PolyDyn Performance Coatings

11211 Neeshaw Dr.
Houston, TX 77065
800-765-9396
coatings@polydyntx7.com
polydyn.com
Category: RACING COMPONENTS, ACCESSORIES & SERVICES
Entry on Page 107

Power Automedia

43460 Ridge Park Dr. Suite 170
Temecula, CA 92590
951-677-2626
powerautomedia.com
Category: RACING COMPONENTS, ACCESSORIES & SERVICES
Entry on Page 126

Powermaster Performance

1833 Downs Dr.
West Chicago, IL 60185
630-957-4019
powermasterperformance.com
Category: ENGINE COMPONENTS
Entry on Page 66

Precision Turbo and Engine

9401 Georgia St., Ste. 2
Crown Point, IN 46307
855-996-7832
pte-orders@wabtec.com
shop.precisionturbo.net
Category: ENGINE COMPONENTS
Entry on Page 40

Pro Ultrasonics

3100 NC 18 US 64
Morganton, NC 28655
828-584-1005
proultrasonics.com
Category: MACHINERY, TOOLS & EQUIPMENT
Entry on Page 150

ProCharger Supercharger Systems

14801 W. 114th Terr.
Lenexa, KS 66215
913-338-2886
racing@procharger.com
procharger.com
Category: ENGINE COMPONENTS
Entry on Page 66

PROFORM Parts (Specialty Auto Parts USA)

26708 Groesbeck Hwy.
Warren, MI 48089
586-774-2500
info@proformparts.com
proformparts.com
Category: ENGINE COMPONENTS
Entry on Page 42

Pyrotect Racing Cells

975 SW First St.
Redmond, OR 97756
800-669-2355
Support@pyrotectracingcells.com
pyrotect.com
Category: CHASSIS, DRIVELINE & SUSPENSION COMPONENTS
Entry on Page 92

Pyrotect Safety Gear

975 SW First St.
Redmond, OR 97756
800-669-2355
support@pyrotect.com
pyrotect.com
Category: RACING COMPONENTS, ACCESSORIES & SERVICES
Entry on Page 126

Quantum Machinery Group

7110 Expo Dr., Ste. D
Charlotte, NC 28269
704-703-9400
quantummachinery.com
Category: MACHINERY, TOOLS & EQUIPMENT
Entry on Page 150

Quick Performance

303 Sondrol Ave.
Ames, IA 50010
515-232-0126
quickperformance.com
Category: CHASSIS, DRIVELINE & SUSPENSION COMPONENTS
Entry on Page 92

QuickJack

250 Dove Ct.
Santa Paula, CA 93060
888-262-3880
sales@quickjack.com
quickjack.com
Category: MACHINERY, TOOLS & EQUIPMENT
Entry on page 142

Race Tools Direct

PO Box 91
East Palestine, OH 44413
440-941-8533
racetoolsdirect.com
Category: MACHINERY, TOOLS & EQUIPMENT
Entry on Page 151

Race Winning Brands

7201 Industrial Park Blvd.
Mentor, OH 44060
440-951-6600
rwbteam.com
Category: ENGINE COMPONENTS
Entry on Page 67

Raceceiver

872 Main St. SW D-2
Gainesville, GA 30501
770-287-8544
sales@raceceiver.com
raceceiver.com
Category: RACE TRACK EQUIPMENT & SUPPLIES
Entry on Page 158

Racelogic

40000 Grand River, Ste. 100
Novi, MI 48375
248-994-9050
sales@racelogic.com
vboxmotorsport.com
Category: RACING COMPONENTS, ACCESSORIES & SERVICES
Entry on page 108

Racetech Manufacturing Ltd.

18 Barnes St.
Seaview, Wellington 5010
New Zealand
704-450-4507
racetech-usa.com
Category: RACING COMPONENTS, ACCESSORIES & SERVICES
Entry on Page 126

Racing Electronics

555 MRN Dr. NW
Concord, NC 28027
800-272-7111
racingelectronics.com
Category: RACING COMPONENTS, ACCESSORIES & SERVICES
Entry on Page 127

Radium Engineering LLC

14910 SE Morning Way, Ste. 103
Clackamas, OR 97015
503-783-8850
radiumauto.com
Category: ENGINE COMPONENTS
Entry on Page 67

Raybestos Powertrain LLC

711 Tech Dr.
Crawfordsville, IN 47933
800-686-4729
raybestospowertrain.com
Category: CHASSIS, DRIVELINE & SUSPENSION COMPONENTS
Entry on Page 92

RC Components

373 Mitch McConnell Way
Bowling Green, KY 42101
800-360-0915
rccomponents.com
Category: CHASSIS, DRIVELINE & SUSPENSION COMPONENTS
Entry on Page 93

Redtide Canopies

1338 W. 12040 S
Riverton, UT 84065
888-616-3611
sales@redtidecanopies.com
redtidecanopies.com
Category: RACING COMPONENTS, ACCESSORIES & SERVICES
Entry on Page 109

Remflex

PO Box 170
Mineral, WA 98355
866-641-SEAL
info@remflex.com
remflex.com
Category: ENGINE COMPONENTS
Entry on Page 44

Retro-Fit USA

1572 N. Old US Hwy. 23
Howell, MI 48843
810-625-2889
retro-fitusa.com
Category: RACING COMPONENTS, ACCESSORIES & SERVICES
Entry on Page 127

Rhino Tuff Tanks

411 W. Congress St.
Maple Lake, MN 55358
630-527-9933
rhinotufftanks.com
Category: RACE TRACK EQUIPMENT & SUPPLIES
Entry on Page 159

RMC Engine Rebuilding Equipment

5775 Bridgeview Ctr.
Saginaw, MI 48604
989-754-3611
rmcengine.com
Category: MACHINERY, TOOLS & EQUIPMENT
Entry on Page 151

Ron Davis Racing Products

7334 N. 108th Ave.
Glendale, AZ 85307
623-877-5000
info@rondavisradiators.com
rondavisradiators.com
Category: ENGINE COMPONENTS
Entry on Page 67

ROTEC/Anger Assoc.

10200 Freshwater Ct.
Traverse City, MI 49686
248-685-8148
info@angerinc.com
rotec-munich.de/en/
Category: RACING COMPONENTS, ACCESSORIES & SERVICES
Entry on Page 127

S&S Diesel Motorsport

1471 W. Tipton St.
Seymour, IN 47274
812-521-0123
ssdiesel.com
Category: ENGINE COMPONENTS
Entry on Page 68

SBI

2108 Utopia Ave.
Nashville, TN 37211
615-248-6281
sbintl.com
Category: ENGINE COMPONENTS
Entry on Page 46

SCE Gaskets

424 William Springs Rd.
Mt. Pleasant, TN 38474
661-728-9200
scegaskets.com
Category: ENGINE COMPONENTS
Entry on Page 68

Schaeffer's Specialized Lubricants

2600 S. Broadway
St. Louis, MO 63118
800-325-9962
info@schaefferoil.com
schaefferoil.com
Category: RACING COMPONENTS, ACCESSORIES & SERVICES
Entry on Page 110

Schultz Engineered Products

2530 Asbury Ave.
Neptune, NJ 07753
845-742-9244
schultzproducts.com
Category: CHASSIS, DRIVELINE & SUSPENSION COMPONENTS
Entry on Page 93

SCT

4150 Church St., Ste. 1024
Sanford, FL 32771
407-774-2447
marketing@drivesystems.com
scflash.com
Category: RACING COMPONENTS, ACCESSORIES & SERVICES
Entry on Page 128

Serdi Corporation

301 Cayuga Dr., Ste. C
Mooresville, NC 28117
770-493-8220
customerservice@serdi-usa.com
serdimachines.com
Category: MACHINERY, TOOLS & EQUIPMENT
Entry on Page 143

Service Precision Grinding

2113 State Route 31
Port Byron, NY 13140
315-776-9602
drill-grinder.com
Category: MACHINERY, TOOLS & EQUIPMENT
Entry on Page 152

Shocker Hitch

2801 3rd Ave. SW
Jamestown, ND 58401
701-707-2666
shockerhitch.com
Category: RACING COMPONENTS, ACCESSORIES & SUPPLIES
Entry on Page 128

ShopSabre

21673 Cedar Ave.
Lakeville, MN 55044
952-461-4570
shopsabre.com
Category: MACHINERY, TOOLS & EQUIPMENT
Entry on Page 152

SHW Gmh

2840 Gilchrist Rd., Bldg. 14B
Akron, OH 44305
949-255-5787
shw.de
Category: CHASSIS, DRIVELINE & SUSPENSION COMPONENTS
Entry on Page 93

Silver Sport Transmissions

2250 Stock Creek Blvd
Rockford, TN 37853
865-609-8187
info@shiftsst.com
shiftsst.com
Category: CHASSIS, DRIVELINE & SUSPENSION COMPONENTS
Entry on Page 83

SimGear

803C Albion Ave.
Schaumburg, IL 60193
630-283-2090
simgear.com
Category: RACING COMPONENTS, ACCESSORIES & SERVICES
Entry on Page 128

Slade Shock Technology

4115 Eagleville Rd.
Fostoria, OH 44830
704-232-1127
sladeshocktechnology.com
Category: CHASSIS, DRIVELINE & SUSPENSION COMPONENTS
Entry on Page 94

Southern Adrenaline

5001 E. FM 1187, Ut. 210
Burleson, TX 76028
817-371-2350
southernadrenaline.net
Category: RACING COMPONENTS, ACCESSORIES & SERVICES
Entry on Page 129

SPAL USA

1731 SE Oralabor Rd.
Ankeny, IA 50021
630-336-5614
spalusa.com
Category: ENGINE COMPONENTS
Entry on Page 68

Speedway Motors

340 Victory Ln.
Lincoln, NE 68528
800-979-0122
speedwaymotors.com
Category: ENGINE COMPONENTS
Entry on Page 69

Stainless Headers Mfg.

1135 N. 7th St.
Lake City, MN 55041
800-290-3920
sales@stainlessheaders.com
stainlessheaders.com
Category: ENGINE COMPONENTS
Entry on Page 48

Stainless Works

10145 Philipp Pkwy.
Streetsboro, OH 44241
800-878-3635
stainlessworks.net
Category: ENGINE COMPONENTS
Entry on Page 69

Steering Buddy

4511 Oakwood Dr.
Anniston, AL 36206
256-624-0645
steeringbuddy.com
Category: RACING COMPONENTS, ACCESSORIES & SERVICES
Entry on Page 129

Stroud Safety

4101 S. May Ave.
Oklahoma City, OK 73119
405-632-2022
stroudsafety.com
Category: RACING COMPONENTS, ACCESSORIES & SERVICES
Entry on Page 129

SunCoast Performance

631 Anchors St. NW
Fort Walton Beach, FL 32548
850-864-2361
suncoastperformance.com
Category: CHASSIS, DRIVELINE & SUSPENSION COMPONENTS
Entry on Page 84

Sundown Audio

514 W. 21st St.
Newton, NC 28658
828-459-1980
sundownaudio.com
Category: RACE TRACK EQUIPMENT & SUPPLIES
Entry on Page 159

Sunnen Products Company

7910 Manchester Rd.
St. Louis, MO 63143
800-325-3670
sunnen.com
Category: MACHINERY, TOOLS & EQUIPMENT
Entry on Page 144

Superior Bearing & Supply

2505 12th Ave W.
Bradenton, FL 34205
800-423-5318
andrea@superiorbearings.com
superiorbearings.com
Category: CHASSIS, DRIVELINE & SUSPENSION COMPONENTS
Entry on Page 94

Swift Filters

24040 Forbes Rd.
Oakwood, OH 44146
440-735-0995
swiftfilters.com
Category: ENGINE COMPONENTS
Entry on Page 69

Swift Springs USA

15330 Fairfield Ranch Rd., Ste. I
Chino Hills, CA 91709
909-393-8623
swiftsprings.com
Category: CHASSIS, DRIVELINE & SUSPENSION COMPONENTS
Entry on Page 94

Technocraft Cabinets

1540 N. Main St.
Mount Pleasant, TN 38474
931-379-5500
trailer cabinets.com
Category: RACING COMPONENTS, ACCESSORIES & SERVICES
Entry on Page 129

The Tuning School

Brooksville, FL
727-264-8875
info@thetuningschool.com
thetuningschool.com
Category: RACING COMPONENTS, ACCESSORIES & SERVICES
Entry on Page 111

Thermo Tec Automotive

PO Box 96
Greenwich, OH 44837
800-274-8437
team@thermotec.com
thermotec.com
Category: RACING COMPONENTS, ACCESSORIES & SERVICES
Entry on Page 112

TI Automotive/Walbro

2020 Taylor Rd.
Auburn Hills, MI 48326
248-296-8872
aftermarket.tiautomotive.com
Category: ENGINE COMPONENTS
Entry on Page 70

SUPPLIERS INDEX

Timpte

100 Timpte Pkwy.
David City, NE 68632
402-954-8001
timpte.com
Category: RACING COMPONENTS, ACCESSORIES & SERVICES
Entry on Page 130

Titus Performance Products

9875 Adams Willett Rd.
Nanjemoy, MD 20662
301-932-9292
titusperformance@gmail.com
titusperformanceproducts.com
Category: ENGINE COMPONENTS
Entry on Page 70

Top Street Performance

15050 Shoemaker Ave.
Santa Fe Springs, CA 90670
562-926-5858
sabine@topstreetperformance.com
topstreetperformance.com
Category: ENGINE COMPONENTS
Entry on Page 70

TOPDON USA

400 Commons Way, Ste. A
Rockaway, NJ 07866
317-488-0273
topdon.us
Category: MACHINERY, TOOLS & EQUIPMENT
Entry on Page 153

Trackside Systems

1321 Davis St SW
Canton, OH 44706
330-754-3364
tracksideapp.com
Category: RACE TRACK EQUIPMENT & SUPPLIES
Entry on Page 159

Trailer Alarms

301 Main Plaza #241
New Braunfels, TX 78130
877-604-7381
trailer-alarms.com
Category: RACING COMPONENTS, ACCESSORIES & SERVICES
Entry on Page 130

Trensor

9781 Irvine Center Dr.
Irvine, CA 92618
949-379-6730
zgibson@trensor.com
trensor.com
Category: RACING COMPONENTS, ACCESSORIES & SERVICES
Entry on Page 130

TRUMPF

111 Hyde Rd.
Farmington, CT 06032
860-674-8226
us.trumpf.com
Category: MACHINERY, TOOLS & EQUIPMENT
Entry on Page 153

Turbosmart

909-476-2570
sales@turbosmartusa.com
turbosmart.com
Category: ENGINE COMPONENTS
Entry on Page 50

Turbostart Batteries

2847 John Deere Dr., Ste. 102
Knoxville, TN 37917
865-394-6535
turbostart.com
Category: ENGINE COMPONENTS
Entry on Page 70

Turn One Performance Steering

40 W. Morley Dr.
Saginaw, MI 48601
989-759-4206
mark@turnonesteering.com
turnonesteering.com
Category: CHASSIS, DRIVELINE & SUSPENSION COMPONENTS
Entry on Page 95

TW Metals

707 Eagleview Blvd., Ste. 200
Exton, PA 19341
800-545-5000
twmetals.com
Category: RACING COMPONENTS, ACCESSORIES & SERVICES
Entry on Page 130

UB Machine

1615 Lincoln Hwy. E.
New Haven, IN 46774
260-493-3381
ubmachine.com
Category: CHASSIS, DRIVELINE & SUSPENSION COMPONENTS
Entry on Page 95

Ultimate Awning

11534 Parkside Ln. N.
Champlin, MN 55316
612-816-9644
info@ultimateawning.com
ultimateawning.com
Category: RACING COMPONENTS, ACCESSORIES & SERVICES
Entry on Page 113

Ultra Shield Race Products

19313 Hwy. 69 S.
Flint, TX 75762
903-894-3550
ultrashieldrace.com
Category: RACING COMPONENTS, ACCESSORIES & SERVICES
Entry on Page 130

United Race Parts

150 Oswalt Amity Rd., Ste. 101D
Troutman, NC 28166
704-500-2000
unitedraceparts.com
Category: RACE TRACK EQUIPMENT & SUPPLIES
Entry on Page 159

Van Norman Machine India Pvt Ltd

55 Industrial Area Phase 2
Chandigarh, 160002
India
91-99-155-44777
robinsmachines.com
Category: MACHINERY, TOOLS & EQUIPMENT
Entry on Page 154

Van Sant Enterprises

75 Truman Rd.
Pella, IA 50219
641-628-3860
marketing@trick-tools.com
tricktools.com
Category: MACHINERY, TOOLS & EQUIPMENT
Entry on Page 154

Vanson Leathers

951 Broadway
Fall River, MA 02724
508-678-2000
vansonleathers.com
Category: RACING COMPONENTS, ACCESSORIES & SERVICES
Entry on Page 130

VP Racing Fuels

10205 Oasis St.
San Antonio, TX 78216
210-635-7744
mike.saeger@vpracingfuels.com
vpracingfuels.com
Category: RACING COMPONENTS, ACCESSORIES & SERVICES
Entry on Page 114

Wieland

5100 S. Archibald Ave.
Ontario, CA 91762
708-385-7000
wieland-metalservices.com
Category: RACING COMPONENTS, ACCESSORIES & SERVICES
Entry on Page 115

Wilwood Engineering

4700 Calle Bolero
Camarillo, CA 93012
805-388-1188
wilwood.com
Category: RACING COMPONENTS, ACCESSORIES & SERVICES
Entry on Page 131

Works Innovation

5717 SE 74th St.
Oklahoma City, OK 73135
405-504-8797
meru-safety.com
Category: RACING COMPONENTS, ACCESSORIES & SERVICES
Entry on Page 132

Worldwide Express

2700 Commerce St., Ste. 1500
Dallas, TX 75226
214-720-2400
racing@wwex.com
wwex.com/pri
Category: RACING COMPONENTS, ACCESSORIES & SERVICES
Entry on Page 116

XS Power Batteries

2847 John Deere Dr., Ste. 102
Knoxville, TN 37917
865-688-5953
4xspower.com
Category: ENGINE COMPONENTS
Entry on Page 70

Zamp

251 NW 13th Pl., Ste. 120
Meridian, ID 83642
208-506-3030
zamp-racing.com
Category: RACING COMPONENTS, ACCESSORIES & SERVICES
Entry on Page 132

PERFORMANCE INDUSTRY REPS

EVERY WINNING RACER HAS A GREAT PIT CREW



Scott Lewis Associates has the experience and expertise to grow your sales and brand presence

- | | |
|---------------------|-----------------------|
| Marketing Strategy | Digital Campaigns |
| Product Awareness | Website Development |
| Collateral Creation | Ambassador Management |



Let's Win Together—Contact Us Now!

(516) 387-6100
 info@scottlewisinc.com
 scottlewisinc.com

ALL-MIDWEST SALES

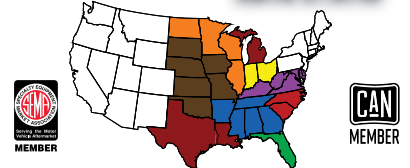

ADMINISTRATIVE OFFICE
 2111 Lanterman Circle • Hinckley, Ohio 44233
 216-225-4564
 j.morehouse@aif.net

Over 50 Years of professional representation of premier companies to all levels of distribution in the Specialty Automotive Aftermarket
www.allmidwestsales.com

ProRep MARKETING

SERVICING THE PERFORMANCE TRUCK & DIESEL MARKETS IN PENNSYLVANIA • NEW YORK • NEW JERSEY MARYLAND • DELAWARE • NEW ENGLAND EASTERN CANADA

CONTACT: ADAM OLSON

14 MEADE LANE
 ENFIELD, CT 06082
 PHONE: 860.698.6022
 AOLSON@PROREPMARKETING.COM

VISIT US AT: WWW.PROREPMARKETING.COM

Team **CSM**
CONSIDINE SALES & MARKETING
 MANUFACTURERS REPRESENTATIVES SERVING AS YOUR FIELD SALES FORCE

CALL: JIM CONSIDINE
 (248) 889-7887
 611 S. Milford Rd.
 Highland, Michigan
jconsidine@considinesales.com

CELEBRATING 50 YEARS OF Excellence In The Automotive Aftermarket
 "AWARDED" SEMA REPS OF THE YEAR

- STREET
- RACE
- TRUCK
- OFF-ROAD
- JEEP
- FLEET

Ballard Allen
 MARKETING, INC.

Performance.....
 We build our business on it

WWW.BALLARDALLEN.COM

Corporate Office:
 711 W. 17th Street Suite F7
 Costa Mesa, CA 92627
 P: 949.722.7716 F: 949.722.7957

ADDITIONAL REGIONAL OFFICES SERVING YOU
 LINCOLN, CA - DENVER, CO - PORTLAND, OR - PHOENIX, AZ

We are here to service your business in the Western 11 States and Western Canada

2019 SEMA REP OF THE YEAR AWARD (7 TIME RECIPIENT) 2019 CAN REP OF THE YEAR AWARD (2 TIME RECIPIENT)

WITH OVER 50 YEARS OF EXPERIENCE & EXPERT STAFF OF 26, WE PROVIDE SALES & MARKETING SERVICES TO ALL FACETS OF THE AUTOMOTIVE AFTERMARKET INDUSTRY.

SALES | MARKETING | ADVERTISING | BRAND MANAGEMENT
 MEDIA SERVICES DATA MANAGEMENT | PROMOTIONAL ADMINISTRATION | EVENT COVERAGE

4084 PIONEER DRIVE | WALLED LAKE, MI 48390
 P 248.360.2700 F 248.360.3704 KUNZMAN.COM MIDWEST | MINK | NORTHEAST | SOUTHEAST | WEST COAST | CANADA

READ PRI'S MISSION STATEMENT AT PERFORMANCERACING.COM/MISSION AND SEND US YOUR FEEDBACK.

ESTABLISHED RACING HELMET BUSINESS FOR SALE

The business was created in 2014 and maintains high net margins of 27%, has minimal ad spend, and sees consistent revenue throughout the year. It generates revenue from Amazon FBA (95%) with lots of room to grow into wholesale. More info at www.conquerhelmets.com

PERFORMANCE INDUSTRY REPS

KAM
MARKETING
MANUFACTURERS REPRESENTATIVE
There's No Substitute for Experience & Integrity

**PERFORMANCE
SPECIALISTS**

Bernie Meyer *bernie@kammarketing.com*
(302) 658-7778
411 Old Baltimore Pike,
Suite 101
Chadds Ford, PA 19317
KamMarketing.com

**AIRHEART
SALES**
"the Performance Reps"
Jim Link Ph. 425.888.2540

Branch Offices
Ladera Ranch, CA • North Bend, WA • Portland OR,
Newport Beach, CA • El Paso, TX • Edmonton, Canada

Territory: AZ, CA, CO, ID, MT, NM, NV,
OR, TX, UT, WA, West Canada
www.airheartsales.com

BOB COOK SALES
SALES & BRAND CONSULTANTS

901-854-4632
www.bobcooksales.com
lesrudd@bobcooksales.com

NEXT LEVEL BRANDING

Thomas Sales and Marketing
Specialists in the Performance, Automotive, Heavy Duty,
Diesel, Agricultural and Industrial Markets.

Central Office:
317-846-7024
Ron.thomasco@sbcglobal.net
www.thomassalesco.com

Indiana, Illinois,
Kentucky, Michigan, Ohio,
West Virginia,
Pennsylvania, Wisconsin.

AD INDEX

ADVANCED CLUTCH TECHNOLOGY INC.	133	COMETIC GASKET INC.	181
AIRHEART SALES	196	CONSIDINE SALES & MARKETING	195
ALL MIDWEST SALES	195	CORE RACE PRODUCTS	163
ALTRONICS INC.	126	CP-CARRILLO INC.	149
ARMAKLEEN COMPANY.	56	CREATIVE RACING PRODUCTS.	85
ATECH MOTORSPORTS	3	CRP CANTRELL RACING PRODUCTS LLC	182
ATL RACING FUEL CELLS	167	CTECH MANUFACTURING	73
AUTOMOTIVE RACING PRODUCTS INC.	35	DAIDO ENGINE BEARINGS	154
BALLARD & ALLEN MARKETING INC.	195	DARANA HYBRID	87
BEHRENT'S PERFORMANCE WAREHOUSE.	150	DARTON INTERNATIONAL INC.	97
BELT DRIVES LTD.	173	DESIGN ENGINEERING INC.	146
BEND-TECH	68	DRIVESHAFT SHOP INC.	174
BETA TOOLS	55	DYERS TOP RODS.	176
BILL MITCHELL HARDCORE RACING PRODUCTS ...	173,174	DYNABRADE INC.	69
BILLET CONNECTION	173	E3 SPARK PLUGS	176
BOB COOK SALES.	196	EDELBROCK LLC.	23
BOKER'S INC.	128	EFILIVE LTD.	161
BRASWELL CARBURETION	172	ENERGY MANUFACTURING LTD.	162
BRIAN CROWER INC.	148	ENGINE ICE - KOST USA.	176
BRODIX INC.	51	EXHAUST GAS TECHNOLOGIES INC.	181
BURDICK'S RV CENTER	62	FITECH EFI.	64
CALLIES PERFORMANCE PRODUCTS INC.	49	FLAMING RIVER INDUSTRIES INC.	54
CALVERT RACING SUSPENSIONS.	169,171	FLATROCK MOTORSPORTS PARK & MOTORCLUB.	198
CAM MOTION	129	FLUIDAMPR-VIBRATECH TVD	165
CANTON RACING PRODUCTS.	131	FUEL INJECTOR CLINIC	152
CECOMP ELECTRONICS	180	GANDRUD PARTS CENTER	128
CENTROID CORP.	66	GEARSTAR PERFORMANCE.	177
CHAMP PANS.	175	GIANT FINISHING	117
CHE PRECISION	91	GOODYEAR TIRE & RUBBER CO.	9,17
COLEMAN MACHINE INC.	153	GRAND BENDING	131
COMEC INC.	65	H-P PRODUCTS	147

HOT SHOT'S SECRET	57	ONE WAY TECHNOLOGIES	181	SCOTT LEWIS ASSOCIATES INC.	195
HOWARDS CAMS	153	ORTHENE CHEMICALS LTD.	5	SCS GEARBOX	95
HYPERMAX ENGINEERING INC.	122	OTR FILTERS	169	SERDI CORP.	120
IDIDIT LLC	174	P1 MANUFACTURING	182	SERVICE STEEL AEROSPACE CORP.	164
IGNITIONEERING/B.R. MOTORSPORTS	43	PACIFIC PERFORMANCE ENGINEERING	33	SETRAB USA	124
INTERCOMP CO.	41	PBM PERFORMANCE PRODUCTS	149	SHAFTECH LTD.	123
ISKY RACING CAMS	118,175	PENSKER RACING SHOCKS	183	SPAL USA	121
JAZ PRODUCTS INC.	175	PERFORMANCE FORGE INC.	168	SPECIALTY AUTO PARTS USA INC.	152
JESEL INC.	151	PERFORMANCE TUBE BENDING INC.	166	SPECIALTY PRODUCTS COMPANY	93
JONES RACING PRODUCTS	47	PETERSON FLUID SYSTEMS INC.	119	SPECIALTY PRODUCTS DESIGN	58
KAM MARKETING INC.	196	PHILADELPHIA RACING PRODUCTS	127	STAINLESS HEADERS MANUFACTURING INC.	125
KEITH BLACK INC.	53	PRO-WERKS	182	THERMO-TEC	183
KINSLER FUEL INJECTION INC.	125	PROREP MARKETING LLC	195	THOMAS SALES CO. INC.	196
KUNZMAN & ASSOCIATES	195	PYROTECT	132	TOP STREET PERFORMANCE	60
LAMIN-X PROTECTIVE FILMS	180	QUALCAST	94	TOPLINE AUTOMOTIVE ENGINEERING	199
LEAR CHEMICAL RESEARCH CORP.	122	QUANTUM MACHINERY GROUP	27	TOYO TIRES USA CORP.	11
LINE2LINE COATINGS	171	QUICK PERFORMANCE	29	TRENSOR	61
MAHLE AFTERMARKET INC.	45	RACE WINNING BRANDS	21	TRIBODYN INC.	183
MAHLE MOTORSPORTS INC.	37	RACING FORCE USA	86	TURN 14 DISTRIBUTION INC.	19
MASTA PERFORMANCE INC.	167	RADIAL BEARING CORP.	180	UNITED ENGINE & MACHINE CO.	59
MAVTV	135	RAINMAKER SOLUTIONS INC.	89	UNITED RACE PARTS LLC	132
MAXX-D TRAILERS	31	RMC ENGINE REBUILDING EQUIPMENT	155	VAC MOTORSPORTS	182
MAXXSONICS USA	157	ROGERS DABBS PERFORMANCE PARTS	67	VAN NORMAN MACHINE INDIA PVT LTD.	6,7,12,13,181,183
MOCAL	168	RON DAVIS RACING PRODUCTS INC.	170	VENDITIO	195
MOROSO PERFORMANCE PRODUCTS INC.	90	ROSS RACING PISTONS	165	WALTON CO.	167
MOSER ENGINEERING INC.	92	ROTLER MANUFACTURING	200	WEHRLI CUSTOM FABRICATION	63
MOTIVE COMPONENTS LTD.	180	SAMPSON	172	WILWOOD ENGINEERING	25
MOTOR STATE DISTRIBUTING	71	SCAT	154	WOOLF AIRCRAFT PRODUCTS INC.	126
NEO SYNTHETIC OIL CO INC.	145	SCHAEFFER MANUFACTURING CO.	2	XS POWER BATTERIES	123
NICKELS PERFORMANCE DISTRIBUTORS	15	SCHUMANN'S SALES & SERVICE	127		
NORTHERN RADIATOR	147	SCOGGIN DICKEY CHEVROLET	151		



FLATROCK
experienceflatrock.com



MOTORCLUB
FLATROCK

FLATROCK INDEX – DRIVER CHALLENGE

HEART RATE 180 BPM

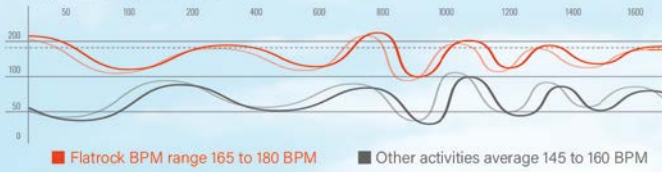

ADRENALINE 9/10



G-FORCE 1.86



SPEED 175 MPH



JOY 100%



CLUBTRACK – SPECIFICATIONS

WORLD CLASS DESIGN & ENGINEERING TILKE GmbH



ELEVATION CHANGE
127 FT (38.66m)

TRACK LENGTH
3.5 MILES (5.6318km)

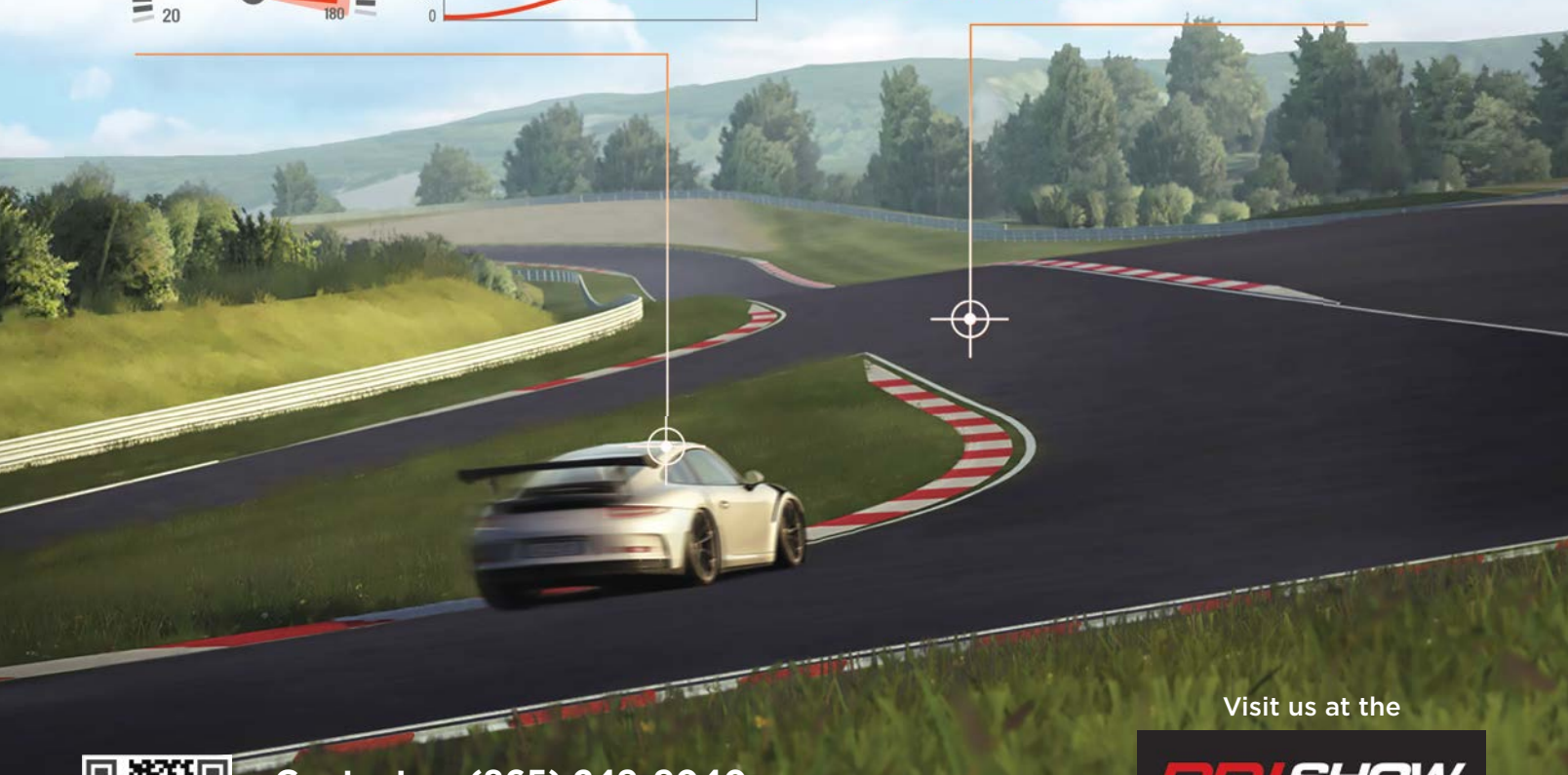
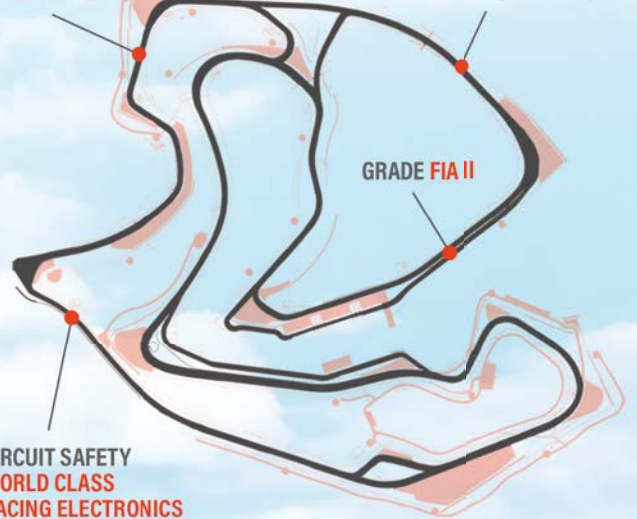

Contact us (865) 249-9040
membership@experienceflatrock.com

FLATROCKMOTORCLUB.COM
Westel, Tennessee on the Cumberland Plateau

Visit us at the

PRISHOW

DECEMBER 7-9, 2023
INDIANAPOLIS INDIANA

We'll be at booth #2211



HYLIFT JOHNSON LIFTERS



DO YOU KNOW WHO MAKES YOURS?

Hy Lift Johnson Lifter Co., the original Iconic brand, is the only global premier designer and manufacturer of engine lifters. Located in Muskegon, Michigan for over 85 years! We manufacture the most complete line of stock and high performance lifters in the industry! Hydraulic, Mechanical, Roller, Flats, Tie Bar Retro fit and Lash adjusters as well as Slow and Fast Leak Down versions and our Patented EDM Direct Shot® and Dual Float™ Bearings. All made in the USA where Quality, Performance, Endurance and Engineering still matter!



THE ONLY COMPANY THAT DOES IT ALL!

As Topline celebrates 50 years of supplying quality import engine parts, we look forward to continuing our tradition of building strong relationships with our customers by delivering dependable, reliable service.

Topline truly embodies the spirit of innovation, integrity, trust and excellence. We understand that success doesn't come from what is done occasionally, but from what is done consistently. We pride ourselves on this commitment. Our products are sold and recommended by the most knowledgeable, experienced and trusted engine builders and parts distributors in the world.

TopLine
Automotive Engineering, Inc.
Parts and Components

800-441-1400 | TOPLINEAUTO.COM

Copyright 2023 Topline Automotive

ROTTLER EM69HP



AUTOMATICALLY
DIGITIZE PORTS AND
CYLINDERS WITH
THE MOST
ADVANCED
MACHINING CENTER
ON THE MARKET

100

YEARS OF COMMITMENT
AND DEDICATION TO THE
GREATEST INDUSTRY
ON EARTH

With our new upgrade to the EM69HP, the increased spindle speed has cut production time and increased our productivity and profitability in the shop.

CHRIS STRAUB



STRAUBTECHNOLOGIES.COM



ENGINE
PERFORMANCE
EXPO
WWW.ENGINEPERFORMANCEEXPO.COM



ROTTLERMFG.COM 1-800-452-0534